

# 8x8 Gardener's Shed - Metal Roof - Assembly Manual



Version 2.7  
January 21, 2020

STOCK CODE #  
GAR88-AK-METAL



Thank you for purchasing  
an 8x8 Gardener's Shed.  
Please take the time to  
identify all the parts prior  
to assembly.

## Safety Points and Other Considerations

Our products are built for use based on proper installation and normal residential use, on level ground. Please follow the instruction manual when building your shed and retain the manual for future maintenance purposes.

Some of the safety and usage measures you may wish to consider include:

- snow load ratings vary by geographical location. If heavy or wet snowfall occurs, it is advisable to sweep the snow off the roof(s).
- if the product is elevated, any structural and building code requirements are solely the customer's responsibility, and should be abided by.
- in high or gusty wind conditions it is advisable to keep the structure securely grounded.
- have a regular maintenance plan to ensure screws, doors, windows and parts are tight.

Customer agrees to hold Outdoor Living Today Partnership and any Authorized Dealers free of any liability for improper installation, maintenance and repair.

**In the event of a missing or broken piece, simply call the Outdoor Living Today Customer Support Line @ 1-888-658-1658 within 30 days of the delivery of your purchase. It is our commitment to you to courier replacement parts, free of charge, within 10 business days of this notification. Replacement parts will not be provided free of charge after the 30 day grace period.**

# What to do before my Shed arrives?



- Become familiar with this assembly manual and determine if you can complete the project yourself or will require a professional contractor.



- One helper is recommended to assist in constructing your shed. It generally takes two people over two days to assemble a shed. If you're hiring a contractor, their rate should be in line with that duration of work.



- Clear the construction area and ensure a clear pathway for delivery when the freight company arrives. Remove all debris: roots, grass, rocks, etc.



- Excavate the site. Contact your local utilities company to ensure there are no gas or electric lines buried in the area before digging.

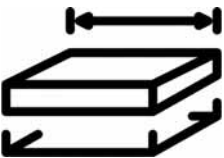

- Decide on the type of foundation you will be using:
  - Concrete slab, or
  - 4-6 inches of crushed gravel with paver stones or 4x4 stringers.

You can find the footprint for your shed on Page 3 of your Assembly Manual.



- If doing the assembly yourself, have all the necessary tools ready to go and in working condition. A list of required tools can be found after the parts list.

# Foundation Types for 8x8 Garden Shed

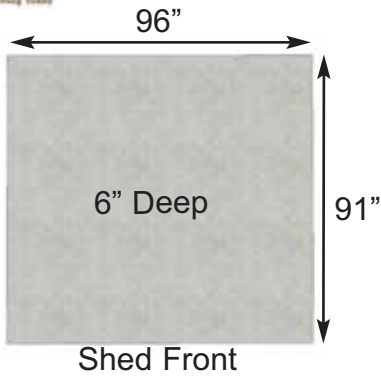

**Concrete Foundation**

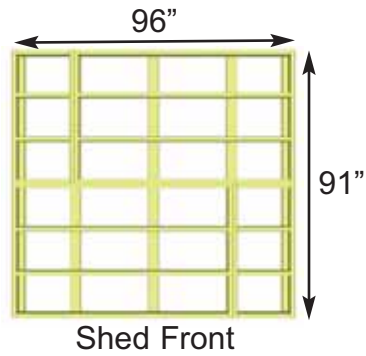

**Floor Frame**

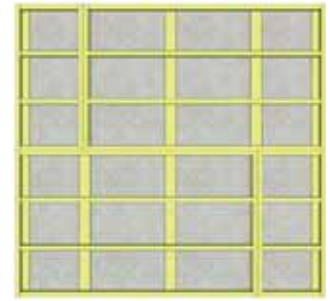

**Completed Foundation**

**Concrete Slab Foundation:**

- Slab must be at least the same size as assembled floor frame (91" x 96") or larger.
- 6" Deep foundation.
- 1.2 Cubic Yards of concrete required.
- A concrete slab will have the longest durability out of your foundation options.

**Once level, a concrete slab is the easiest surface to build on.**

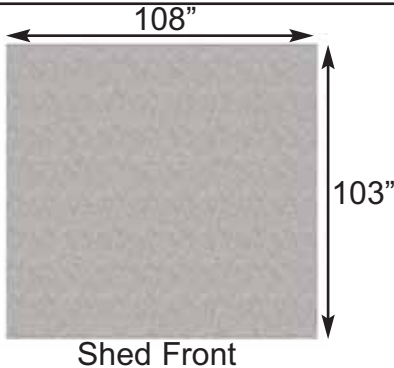

**Gravel Foundation**

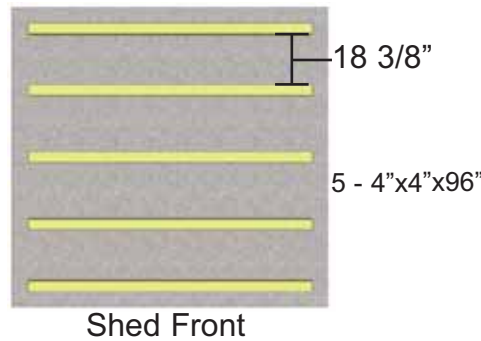

**Gravel Foundation with treated stringers**

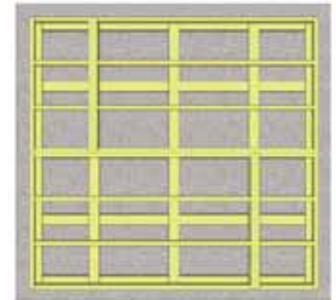

**Completed Foundation**

**Gravel with 4x4 Pressure Treated Stringers:**

- Excavate at least 6" deep, and 6" wider than floor frame on each side.
- 1.5 Cubic Yards of gravel required, approximately 14 wheelbarrows.
- 5 - 4x4 Pressure Treated Stringers 8' long required.
- Evenly spaced, with one at each end of floor frame.

**Saves money on materials, easy to level and work with.**

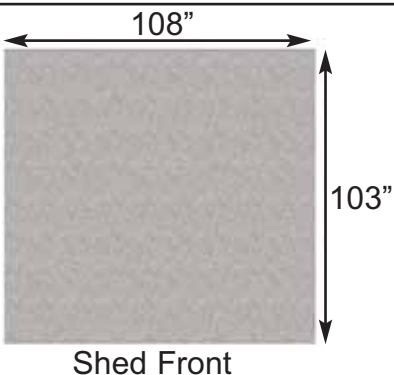

**Gravel Foundation**



**Gravel Foundation with Patio Pavers**

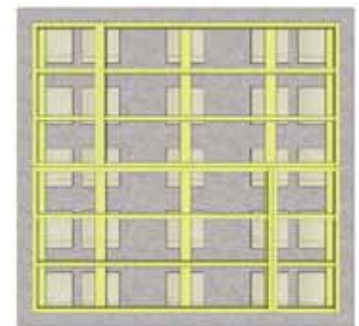

**Completed Foundation**

**Gravel with Patio Paver Stones:**

- Excavate at least 6" deep, and 6" wider than floor frame on each side.
- 1.5 Cubic Yards of gravel required, approximately 14 wheelbarrows.
- 25 patio pavers (8" x 8" or larger).
- Center patio paver stones underneath floor runners and underneath seams in floor joists.

**Patio paver stones are widely available from most landscape stores.**

<p><b>1. Floor Section</b></p> <p><b>Floors</b></p> <p>2 - 45 1/2" x 75" - Floor Joist Frames - Large                  2 - 45 1/2" x 21" - Floor Joist Frames - Small                  4 - 1 1/2" x 3 1/2" x 71 7/8" - Center Floor Joists - Unattached                  5 - 1 1/2" x 3 1/2" x 31" - Floor Runners Short                  5 - 1 1/2" x 3 1/2" x 60" - Floor Runners Long                  2 - 45 3/8" x 74 7/8" - Plywood Floor - Large                  2 - 45 3/8" x 20 7/8" - Plywood Floor - Small</p>	<p><b>Steps</b> ↓</p> <p><b>1-11</b></p>
<p><b>2. Wall Section</b></p> <p><b>Main Wall Panels</b></p> <p>6 - 45 1/2" x 75" - Solid Wall Panels (Bottom Wall Plates unattached)                  6 - 1 1/2" x 2 1/2" x 45 1/2" - Bottom Wall Plates                  1 - 45 1/2" x 75" - Window Wall Panel                  1 - 12" x 73" Narrow Wall Panel</p>	<p><b>Steps</b> ↓</p> <p><b>12-22</b></p>
<p><b>Door Headers</b></p> <p>1 - 1 1/2" x 3 1/2" x 73" Door Jamb                  1 - 2" x 3 1/2" x 45 1/2" - Door Header (Dado cut on edge)</p> <p><b>Top Wall Plates &amp; Gables</b></p> <p>6 - 3/4" x 2 1/2" x 32" - Front &amp; Rear Top Plates                  (2 pieces angle cut on end, 1 piece straight cut both ends)                  2 - 3/4" x 2 1/2" x 86" Side Top Plates (Angle cut on edge)                  4 - Gable Half Walls - Triangular Shaped</p>	<p><b>23-24</b></p> <p><b>25-32</b></p>
<p><b>3. Rafter and Roof Section</b></p> <p><b>Rafter Assembly</b></p> <p>2 - 3/4" x 4 1/2" x 57 1/2" - Roof Ridge Boards Long                  2 - 3/4" x 4 1/2" x 33 1/2" - Roof Ridge Boards Short                  12 - 1 1/2" x 3 1/2" x 56 1/2" - Roof Rafters (angle cut ends)                  4 - 1/2" x 4 1/2" x 45 1/2" - Soffits                  2 - 3/4" x 3 1/2" x 72" - Roof Gussets (angle cut on ends)</p> <p><b>Roof</b></p> <p>16 - 3/4" x 3 1/2" x 48 1/4" - Roof Battens                  12 - 3/4" x 1 1/2" x 14" - Batten Spacers                  6 - 39" wide x 61" long - Metal Roof Panels                  2 - 60" long - Metal Ridge Caps                  Several Pcs - Foam Enclosures</p>	<p><b>Steps</b> ↓</p> <p><b>33-45</b></p> <p><b>46-60</b></p>
<p><b>4. Trim &amp; Miscellaneous Section</b></p> <p><b>Bottom Skirting</b></p> <p>8 - 3/4" x 4 1/2" x 45 1/4" - Bottom Skirting (Bevel)</p> <p><b>Corner &amp; Sidewall Trim</b></p> <p>2 - 1/2" x 2 1/2" x 79" - Narrow Trim Side Wall                  4 - 7/8" x 2 1/2" w x 75" - Filler Trim                  4 - 1/2" x 5 1/2" w x 82" - Wide Corner Trim                  4 - 1/2" x 3 1/2" w x 79" - Corner Trim                  2 - 60" long - Drip Edge                  2 - 1/2" x 4 1/2" w x 43 3/8" - Horizontal Gable Trim Front                  2 - 3/4" x 4 1/2" w x 43 3/8" - Horizontal Gable Trim Rear (Bevel)                  3 - 1/2" x 2 1/2" x 77 1/2" - Narrow Trim (Front and Rear Wall)                  4 - 3/4" x 1 1/2" x 45 1/4" - Top Wall Trim (Bevel)</p> <p><b>Facia Trim</b></p> <p>4 - 3/4" x 2 1/2" x 52 1/2" Facia/Roof Nailing Strips                  4 - 3/4" x 3 1/2" x 58" - Front and Rear Facia (Angle cut on ends - 2 right / 2 left)                  4 - 3/4" x 3 1/2" x 49 1/4" - Side Facia                  2 - Pentagon Facia Plates                  2 - Side Facia Detail Trim Plates - Smaller                  2 - Horizontal Gable Trim Detail Plates - Larger</p> <p><b>Door</b></p> <p>1 - 31 1/2" x 72" - Door                  2 - 1/2" x 2 1/2" x 72" - Interior Vertical Door Stops                  1 - 1/2" x 2 1/2" x 36" - Interior Top Horizontal Door Stop</p>	<p><b>Steps</b> ↓</p> <p><b>61</b></p> <p><b>62-70</b></p> <p><b>71-74</b></p> <p><b>75-78</b></p>
<p><b>**Miscellaneous Pieces</b></p> <p>1 - Window Insert                  1 - Window Trim Pkg - (1-24 1/16" angle cut / 3 -23" straight cut )                  1 - Flower Box Kit                  1 pc - Spare Wall Siding                  2 pcs - Spare Shingles- use to shim door, etc</p>	<p><b>79-82</b></p>



# 8x8 GARDENER - METAL - HARDWARE SHEET

## Hardware Kit (Provided)

2 1/2"  x 228

2"  x 120

2"  x 22  
Black Headed

1 1/4"  x 267

3/4"  x 18  
Silver

3/4"  x 10  
Black Headed

 Silicon Caulking (2)

1/4"x 2"  x 48  
Metal Roof Screw

1 1/2"  x 308  
Finishing

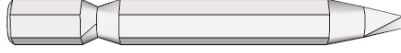
 x 1  
Square Drive Bit

 x 1  
1/4" Nut Driver

 Single Rafter  
Bracket x 4

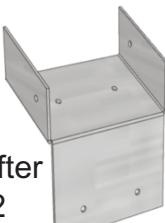
 Double Rafter  
Bracket x 2

 Tee Hinge x3

 Pull Handle

 Black Drop  
Latch

 Metal Roof  
Hangar x 3

 Ridge Board  
Connector x 2

## Tools Required (Not Provided)

 Hammer

 Screw Gun/Drill

 Tape Measure

 Wood Clamp

 Level

 Pliers

 Ladder

 1/8" Drill Bits

## Safety Equipment Required (Not Provided)

 Safety Glasses

 Work Gloves

## Before/During Assembly:

- 1.) Paint each face and edge of your plywood floor with a latex exterior paint.
- 2.) Caulk wall seams if gaps appear.
- 3.) Caulk around window framing.
- 4.) Caulk perimeter between floor plywood and bottom wall plate.
- 5.) Caulk channels in lap siding at the top of your door above the trim, just a drop in each channel.
- 6.) Caulk edge of door threshold (if applicable).
- 7.) Optional: Install a Sill Gasket between floor runners and foundation.
- 8.) Optional: Install an 8" strip of roofing paper below Cedar Ridge Caps for Cedar Roof Sheds.

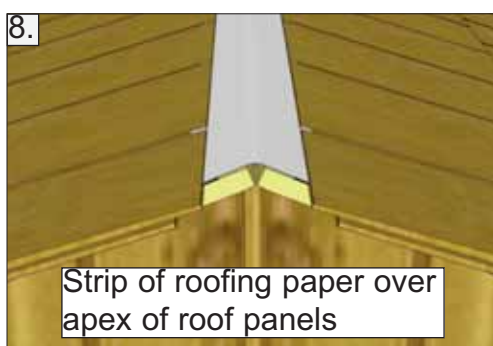
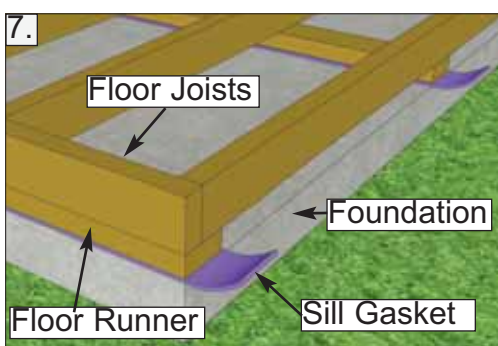
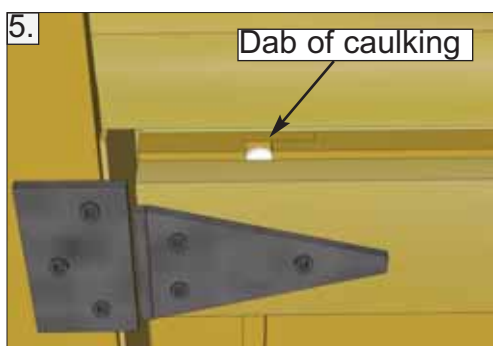
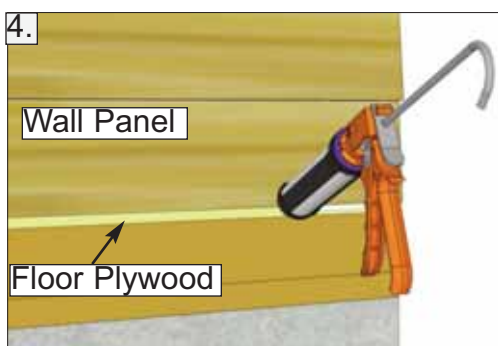
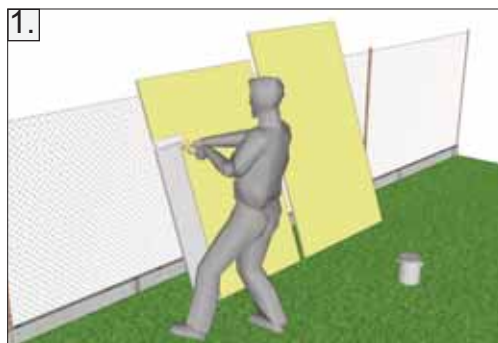

## Routine Maintenance:

- Routinely check all fasteners are tight (ex. Door Hinges, Nails)
- Brush off dirt from walls.
- Brush off snow from roof regularly.
- Routinely remove needles and leaves from roof.

## Painting/Staining

- Your cedar shed, if left untreated, will weather to a silvery grey colour.
- Painting or staining your structure is highly recommended and will prolong the life of your shed.
- You do not need to wait to paint or stain your shed, the wood in your kit has been dried and can be stained or painted immediately.
- Consult your local paint store for the best paint or stain for cedar.
- Optional: stain the inside of your shed. (Note: this will remove the fresh cedar smell.)

# A. Floor Section

Exploded view of all parts necessary to complete Floor Section. Identify all parts prior to starting.

Note: Floor Footprint is 96" wide x 91" deep.

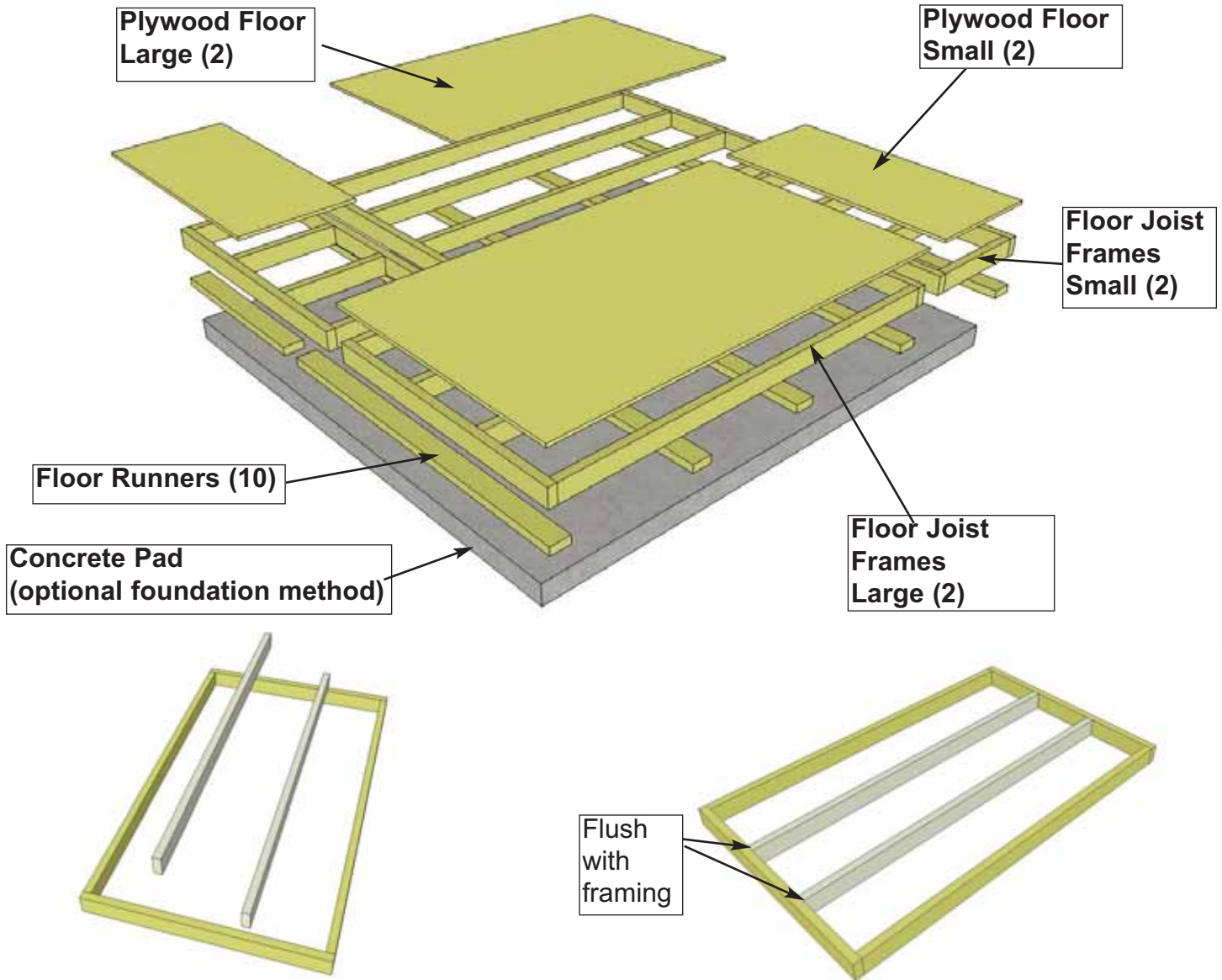

**1.** Lay out **Large Floor Joist Frame** and **2 Floor Joists** as illustrated above. Position Joists equally in Floor Joist Frame. Use **Small Floor Joist Frame** as a template to determine joist position. Position Joist so flush with framing.

Parts (Steps 1 - 6)  
**Floor Joists**  
 (1 1/2" x 3 1/2" x 71 7/8") x 4  
**Floor Joist Frames - Large**  
 (45 1/2" x 75") x 2  
**Floor Joist Frames - Small**  
 (45 1/2" x 21") x 2

Hardware (Steps 1 - 6)  
**S1 - 2 1/2" Screws**  
 x 46 total



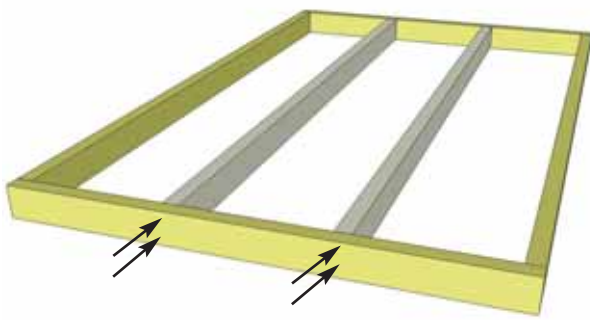

You can find the Square Drive Bit for the screws in with the Hardware Kit Bag.

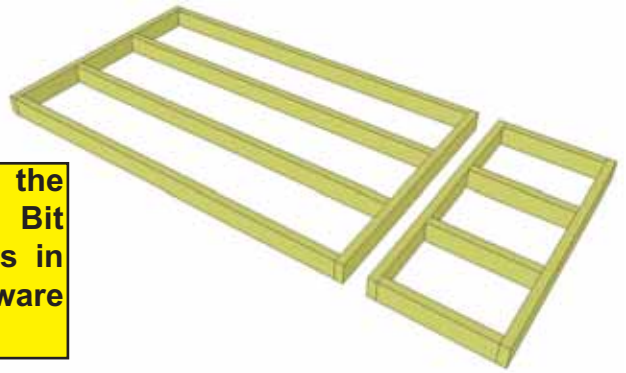

**2.** When correctly positioned, attach each Joist with **4 - 2 1/2" screws** (2 per end).

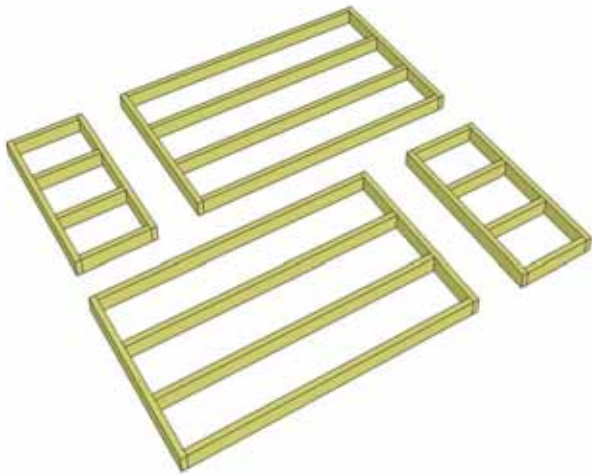

**3.** Lay out **Floor Joist Frames** as illustrated at left. There are 2 larger and 2 smaller Frame Sections. The Footprint for the floor when attached together will be 96" wide x 91" deep.

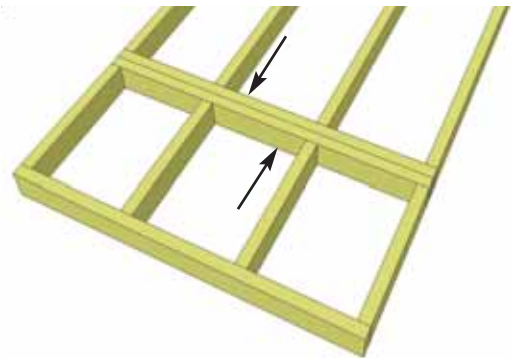

**4.** Attach each large and small floor joist frame together with **6 - 2 1/2" screws** per section.

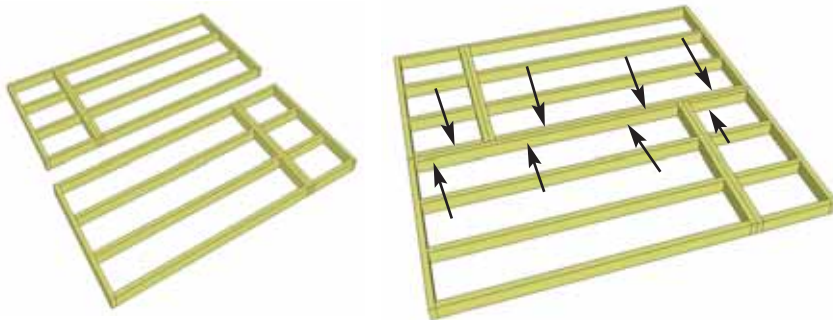

Door goes on 96" side

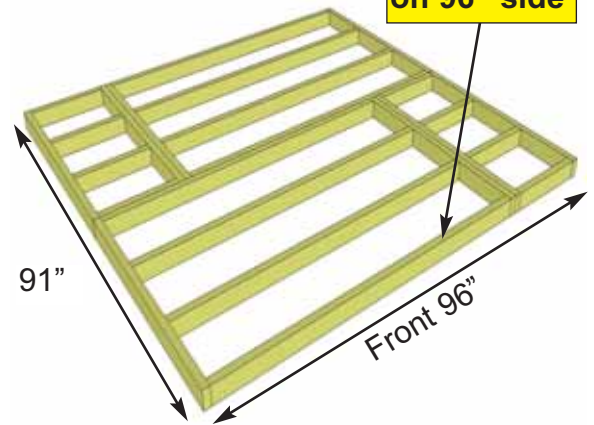

**5.** Complete all large and small frame attachments. Screw each completed section together with **8 - 2 1/2" screws**.

**6.** When completed, your floor footprint should be 96" wide x 91" deep.



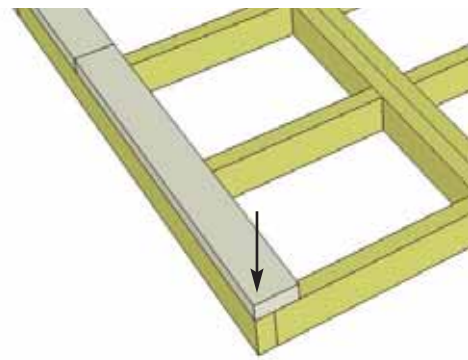
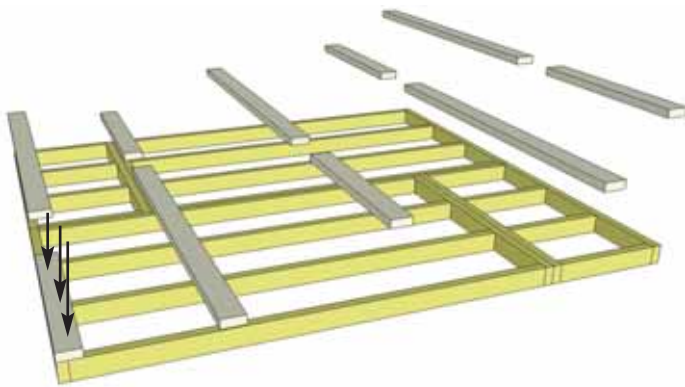

**7.** Attach **Floor Runners** to completed floor frame. There are 2 Floor Runners per 91" side and 5 completed runners in total. Use **3 - 2 1/2" screws** per Floor Runner. Make sure Runners are flush with outside, front and rear floor framing but not overhanging.

Parts (Steps 7 - 9)  
**Floor Runner Short**  
 (1 1/2" x 3 1/2" x 31") x 5  
**Floor Runners Long**  
 (1 1/2" x 3 1/2" x 60") x 5

Hardware (Steps 7 - 9)  
**S1 - 2 1/2" Screws**  
 x 30 total



Concrete Slab Foundation

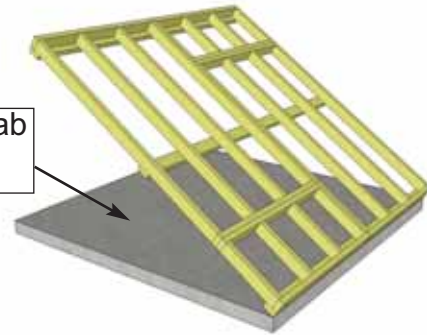

**8.** Complete all Floor Runners.

**Foundations**

**Note:** The floor will be flipped over and floor runners will sit on your foundation. It is important to note that having a level foundation is critical. Choosing a foundation will vary between regions. Typical foundations can be concrete pads or patio stones positioned underneath the floor runners.

**9.** With Floor Runners attached, carefully flip the floor over and place on your foundation. **Caution:** you will need 2 people to assist you. Be careful when laying floor down not to bend or twist floor. When in place, level floor completely.

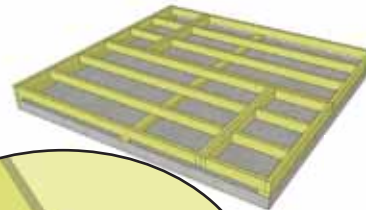

plywood pushed together at seams.

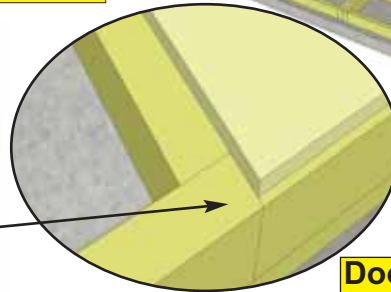
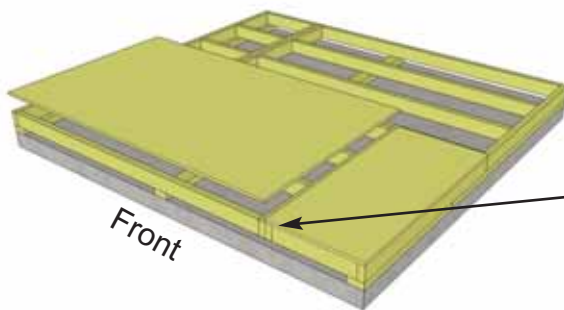

**Door goes on 96" side**

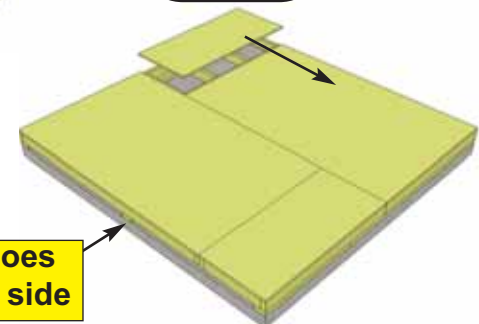

**10.** Position **Plywood Floor** pieces (4) on top of completed floor joists. Plywood is cut slightly smaller than floor framing. Keep plywood seams tight.

Parts (Steps 10 - 11)  
**Floor Plywood Small**  
 (5/8" x 45 3/8" x 20 7/8") x 2  
**Floor Plywood Large**  
 (5/8" x 45 3/8" x 74 7/8") x 2

Hardware (Steps 10 - 11)  
**S2 - 1 1/4" Screws**  
 x 46 total

**11** . With Plywood positioned correctly on floor framing, attach with 1 1/4" screws. Use screws every 16".

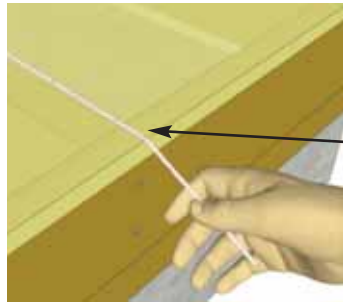

**Hint:** Use a chalk line to mark location of floor joists to determine screw placement.

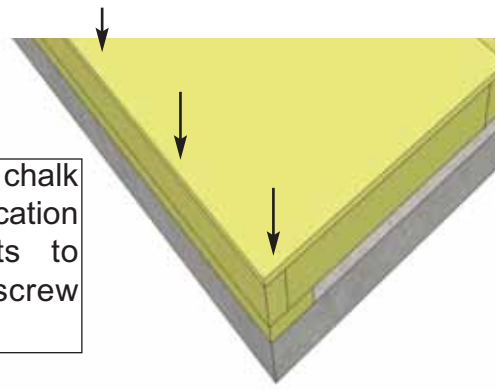

## B. Wall Section

**Exploded view of all parts necessary to complete the Wall Section. Identify all parts prior to starting.**

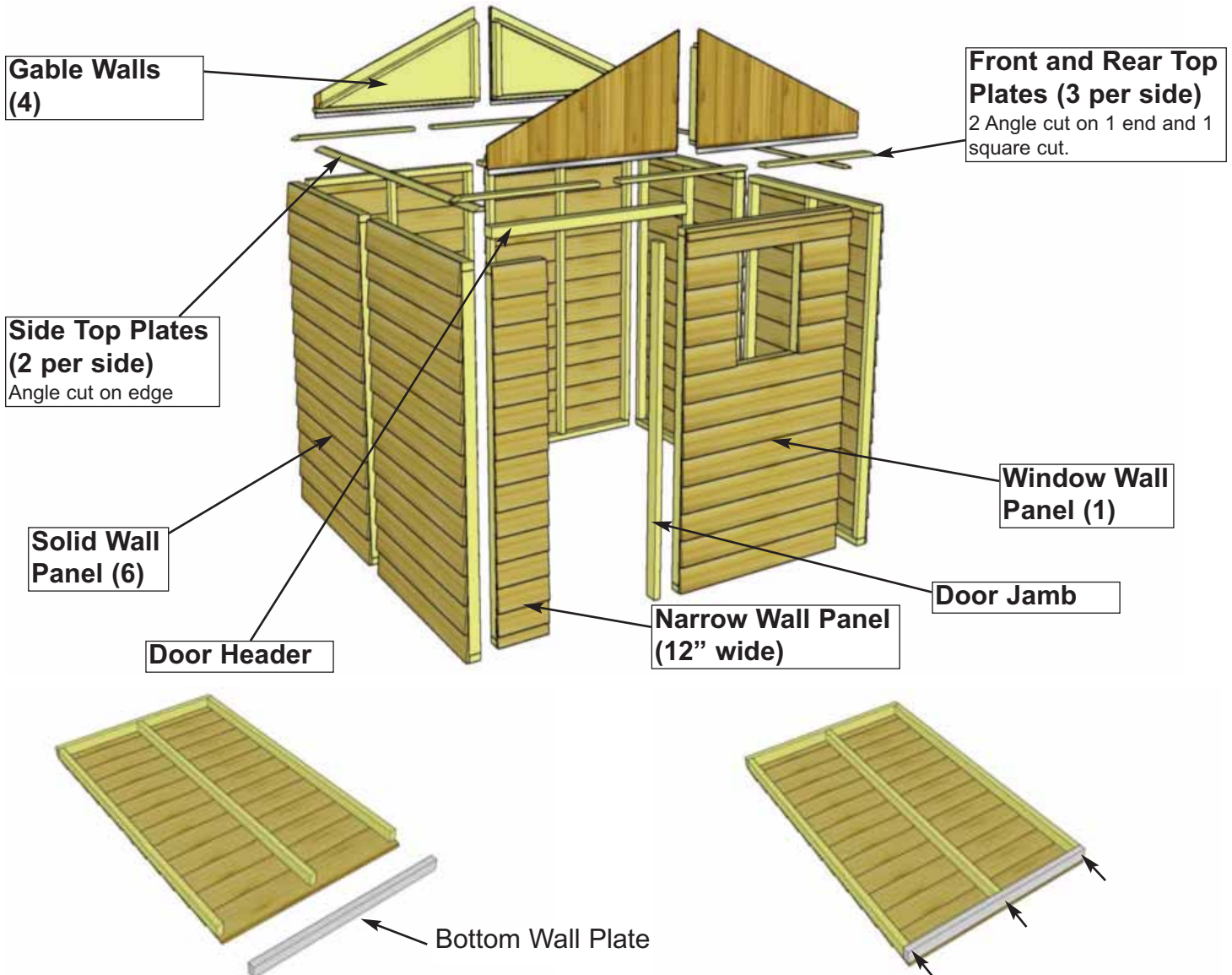

**12.** Starting with Solid Wall Panels, carefully lay panel face down. Position and attach Bottom Wall Plate to bottom of wall studs of each wall panel with 3 - 2 1/2" screws. Position so plates are flush with framing. Note: some Bottom Wall Plates may already be attached to some walls.

Parts (Step 12)  
**Solid Wall Panels**  
 (45 1/2" x 75") x 6  
**Bottom Wall Plates**  
 (1 1/2" x 2 1/2" x 45 1/2") x 6

Hardware (Step 12)  
**S1 - 2 1/2" Screws**  
 x 36 total

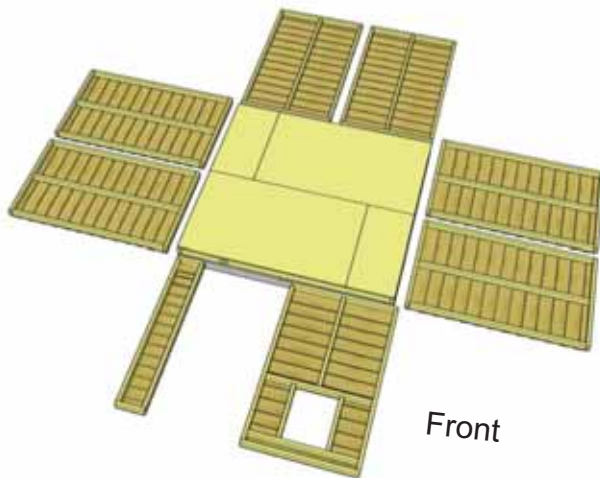

**13.** Lay out all the wall panels and become familiar with their location. On a Standard Kit, there is **1 Window Wall Panel, 6 Solid Wall Panels and 1 Narrow Wall Panel**. Make sure to position panels right side side up so water is directed away from and not into shed. Compare siding with Window Wall Panel to determine proper wall orientation.

Parts (Steps 13 - 21)

- Solid Wall Panels**  
(45 1/2" x 75") x 5
- Window Wall Panel**  
(45 1/2" x 75") x 1

Hardware (Steps 13 - 21)

- S1 - 2 1/2" Screws**  
x 18 total

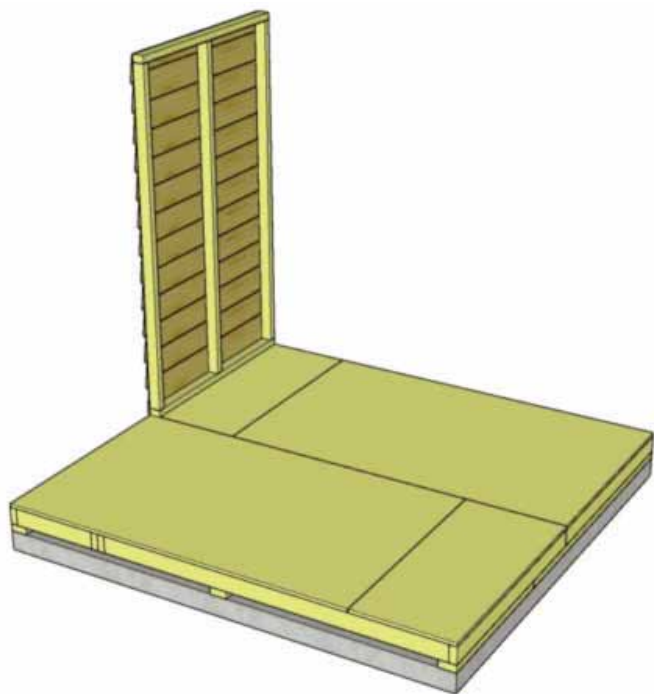

**Important:** Make sure all walls are aligned in their upright position. If not, water may leak into your shed. Unsure if panel is facing up or down? check siding on window wall panel to match alignment.

**14.** Starting at Rear Corner, position a **Solid Wall Panel** on top of plywood floor. The Wall Panel bottom framing will sit flush with floor framing.

**15.** The side wall panels will sit flush at the corner of the floor, with the front and rear wall panels sandwiched between them.  
**Note:** Siding will overhang the floor by approximately 1/2".

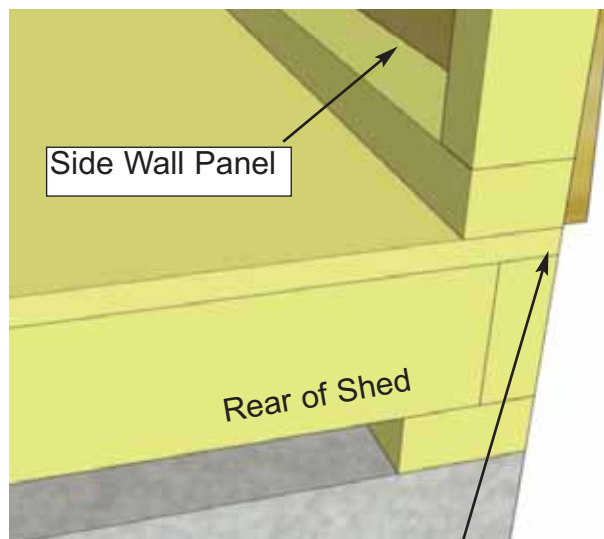

Outside 2x3 framing of wall panel is flush with outside of floor frame when properly aligned.





**Do Not Attach Walls To Floor Until Step 25.**



**Optional:** Caulking seams will help prevent moisture from entering at seam. **Caulking not included in kit.** This will help the longevity of your shed.

**16.** Position a 2nd **Solid Wall** into place on plywood floor. Butt both vertical wall studs of side and rear walls together and attach with **3 - 2 1/2"** screws. Screw at the bottom, middle and top of stud to secure properly.

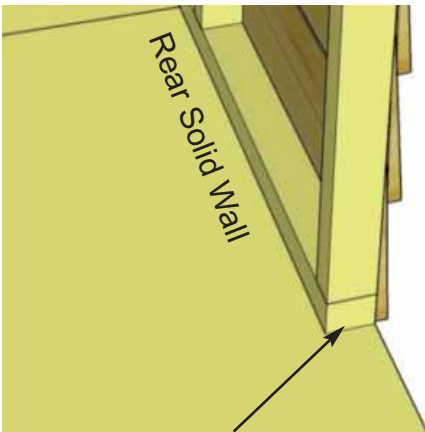

2x3 wall framing flush with floor framing.

**17.** With the corner wall attachment complete, position a third wall panel in place. Wall siding should overhang floor by approximately 1/2". When positioned correctly, attach both rear wall panel studs together as per **Step 16.**

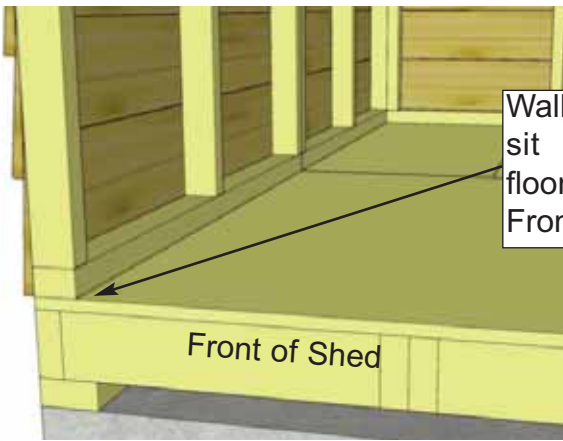
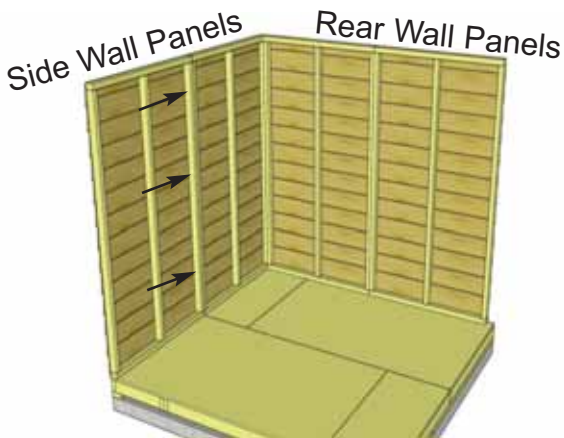

Wall panel will sit flush with floor framing at Front of shed.

**18.** Continue positioning and securing wall panels around your floor. Attach wall studs together as per **Step 16.** Be sure that rear wall panels fit between the side wall panels (sandwiched).

**19.** Complete all side and rear wall attachments.

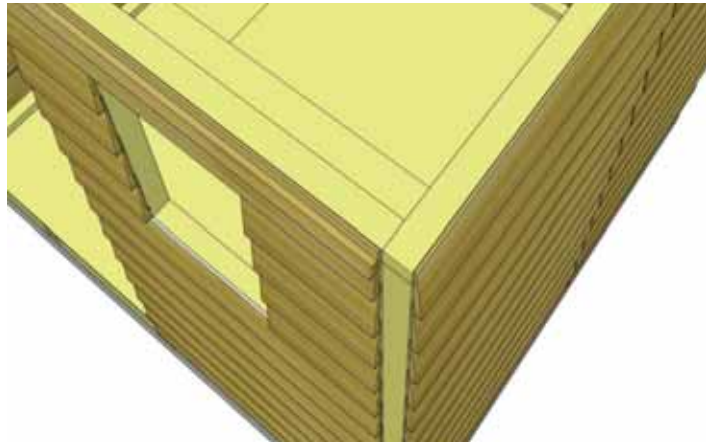

**20.** Place Window Wall Panel in front.

**21.** Make sure top Wall framing is aligned together as illustrated and attach as per **Step 17**.

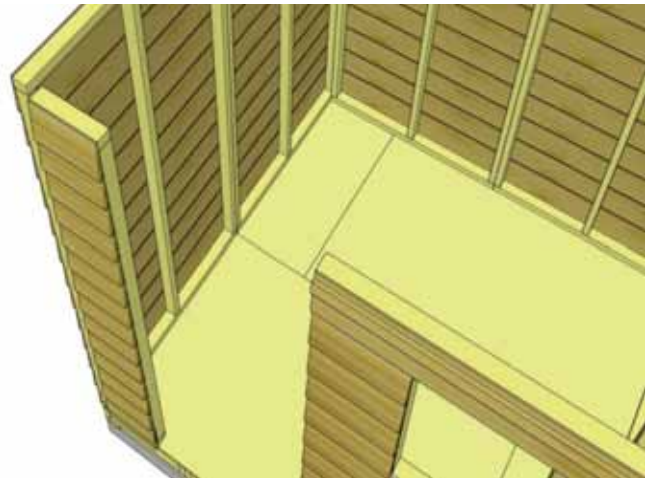
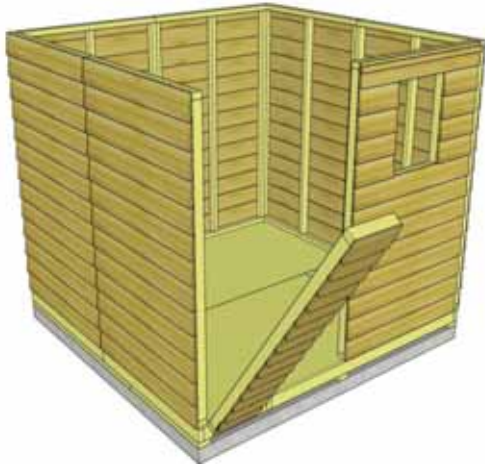

**22.** Position and attach **Narrow Wall Panel** to left side wall stud with **3 - 2 1/2" screws** as per **Step 16**. Note: Narrow Wall is 73" high (2" shorter than Solid Wall Panels). Siding overhangs adjacent wall stud and floor.

Parts (Steps 22)  
**Narrow Wall Panel**  
 (12" x 73") x 1

Hardware (Steps 22)  
**S1 - 2 1/2" Screws**  
 x 3 total

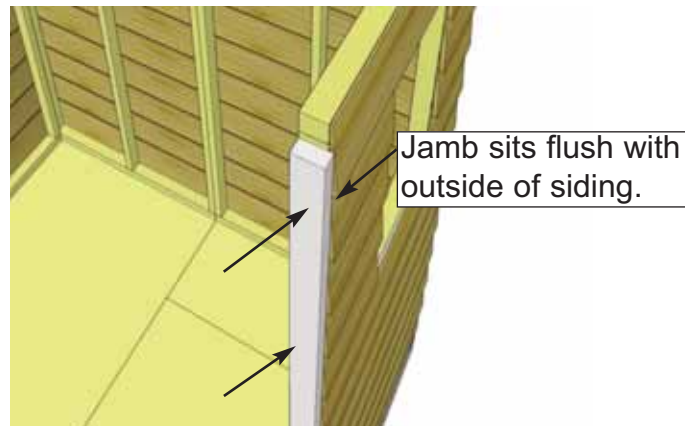
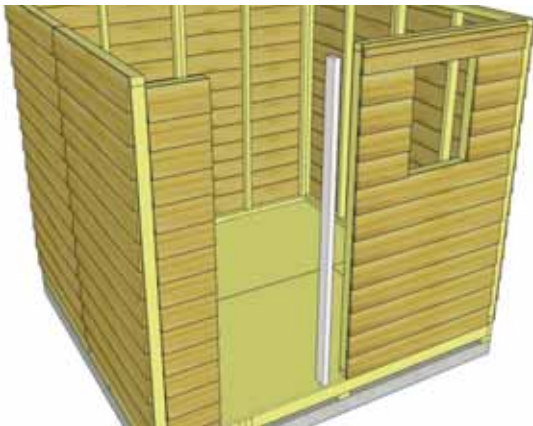

**23.** Locate **Vertical Door Jamb** and position flush against right wall panel stud. The Jamb is 3 1/2" wide and will sit flush to tip of bevel siding. When positioned correctly, secure Jamb using **4 - 2 1/2" screws**.

Parts (Steps 23)  
**Door Jamb**  
 (1 1/2" x 3 1/2" x 73")  
 x 1

Hardware (Steps 23)  
**S1 - 2 1/2" Screws**  
 x 4 total



Header has notch in edge that is positioned to the top and facing outside.

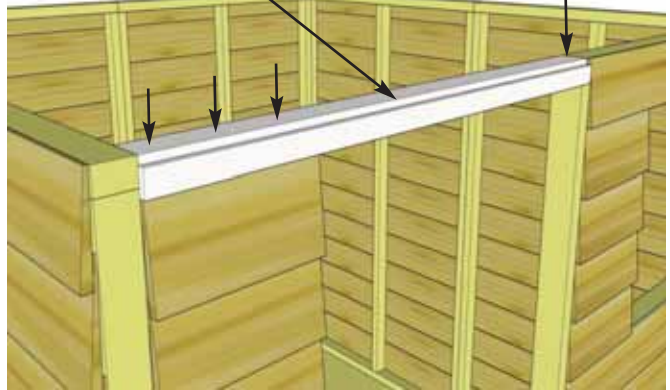
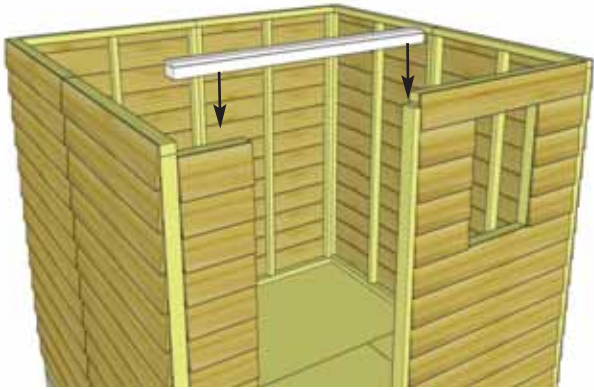

**24.** Position and attach **Door Header** to **Door Jamb** and **Narrow Wall Panel** top framing. Header should sit flush with Door Jamb and Outside of Narrow Wall Panel Siding Attach with **4 - 2 1/2" screws**..

Parts (Steps 24)  
**Door Header**  
 (2" x 3 1/2" x 45 1/2")  
 x 1

Hardware (Steps 24)  
**S1 - 2 1/2" Screws**  
 x 4 total

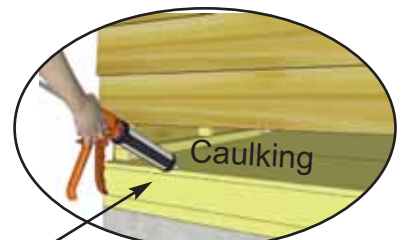
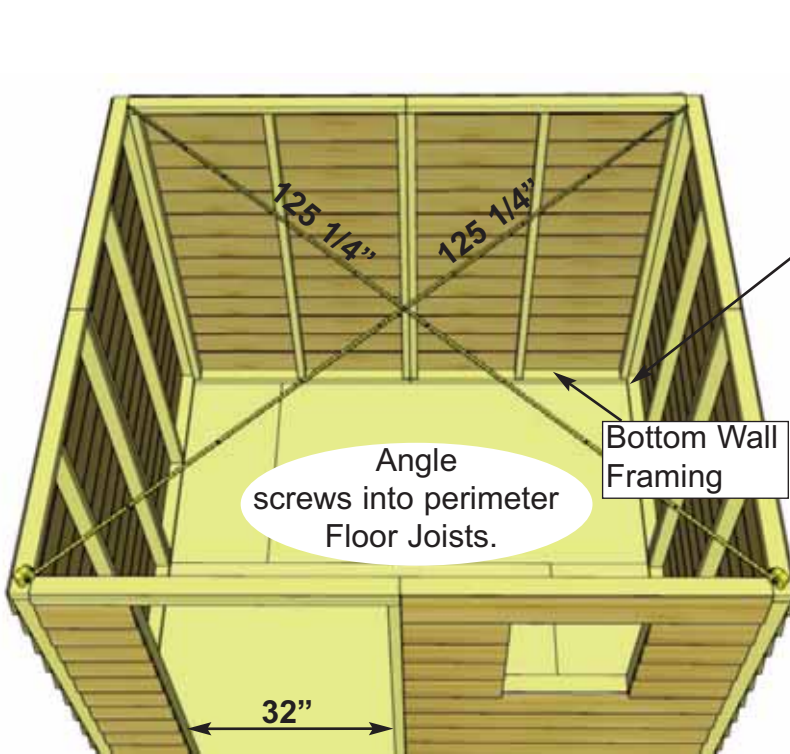

**Optional:** Caulking seams between bottom wall plates and floor will help prevent moisture from entering your shed. **Caulking not included in kit.** This will help the longevity of your shed.

**Advice:** Prior to fastening walls and installing rafters, take time to confirm your walls are level, square and plumb.

Measure diagonal at top and bottom of walls corner-to-corner. This should be approximately 125 1/4". More importantly, if measurements are not within 1/4", your walls are not square. Adjusting now will make it easier to assemble the roof section later.

Confirm Doorway Opening is 32" at top and bottom.

**25.** When all walls are attached together, check alignment with the floor. Bottom wall framing should sit flush with outside of floor joists. **Confirm 32" wide door opening at bottom.** When positioned correctly, fasten bottom wall plates to floor using **4 - 2 1/2" screws** per wall panel.

Hardware (Steps 25)  
**S1 - 2 1/2" Screws**  
 x 32 total



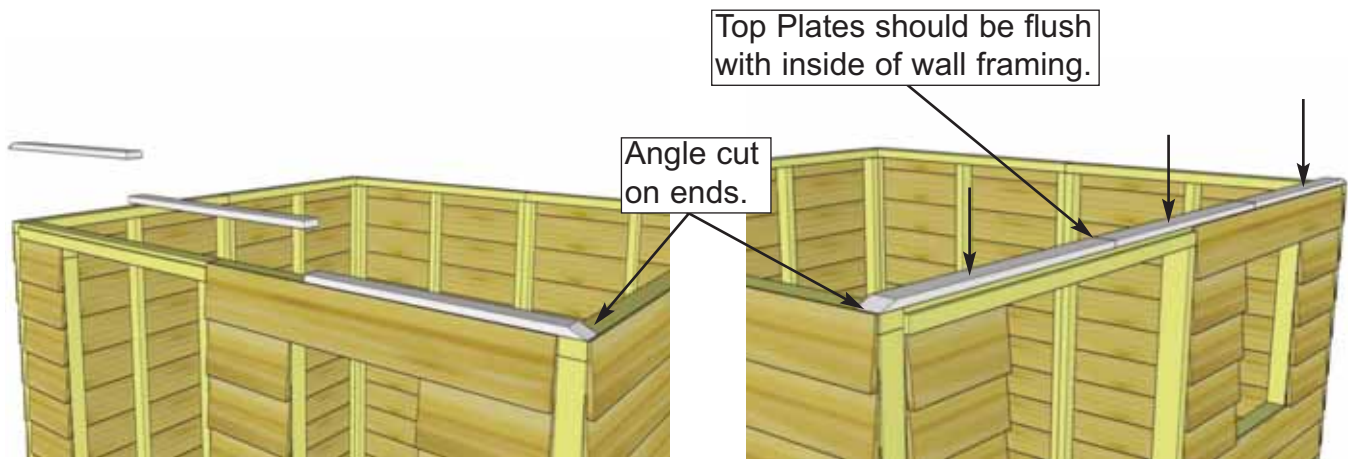

**26.** Position **Front Top Plates** on top of wall studs so they are flush on the inside with 2x3 wall framing. There are 3 pieces of Front Top Plates (2 angle cut on one end and one straight cut on both ends). Together, the plates should be centered evenly on the wall left to right. Attach by screwing down into top wall framing with **3 - 2" screws** per piece. Complete both front and rear of shed.

Hardware (Steps 26,28)  
**S3 - 2" Screws**  
 x 18 total

Parts (Steps 26,28)  
**Front & Rear Top Plates**  
 (3/4" x 2 1/2" x 32") x 6  
 (2 angled end, 1 straight)

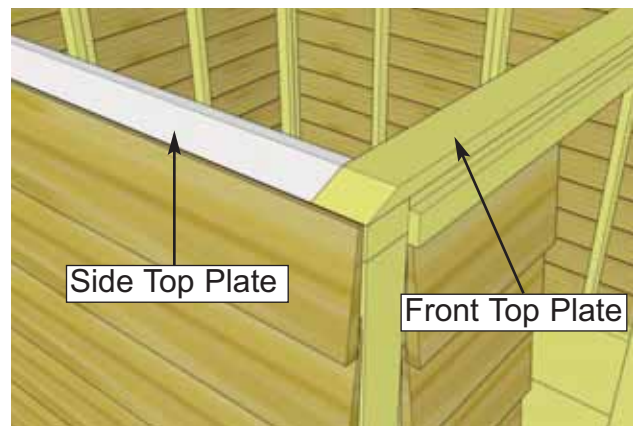
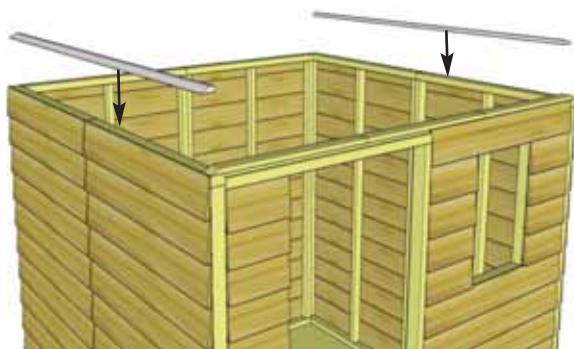

**27.** Next, attach 2 **Side Top Plates** (1 per side). The side top plates are angle cut down the edge. Once again, position top plate on wall plate so it is flush with inside of wall framing. Side plate should also be flush with Front Top Plate. Secure with **4 - 2" screws** per piece.

Hardware (Steps 27)  
**S3 - 2" Screws**  
 x 8 total

Parts (Steps 27)  
**Side Top Plates**  
 (3/4" x 2 1/2" x 86") x 2  
 (angle cut on edge)

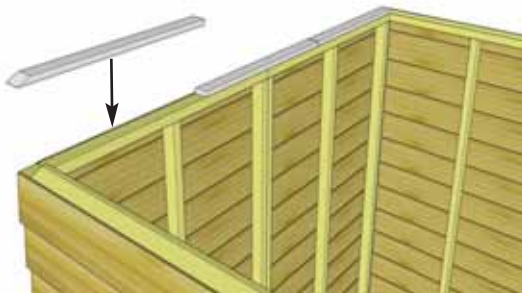

**28.** Position the Rear Top Plates on back wall to complete as per **Step 26**. Use **3 - 2" screws** per piece.

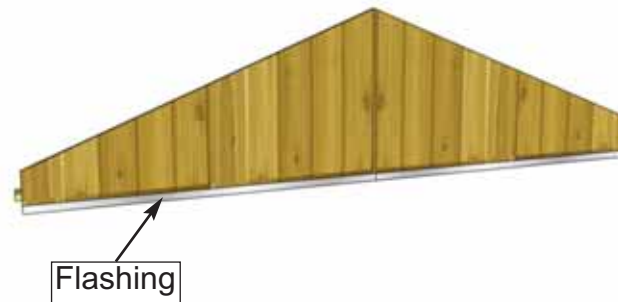
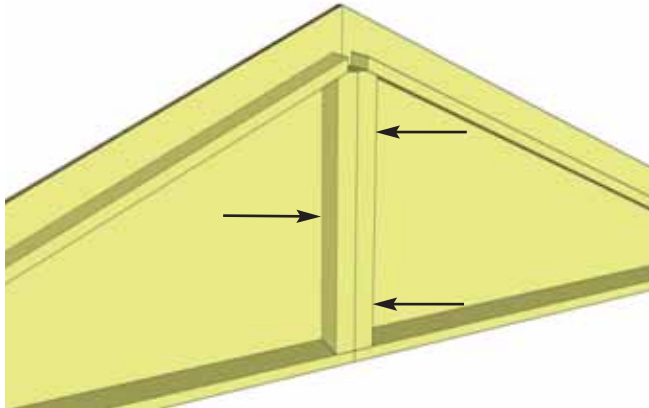
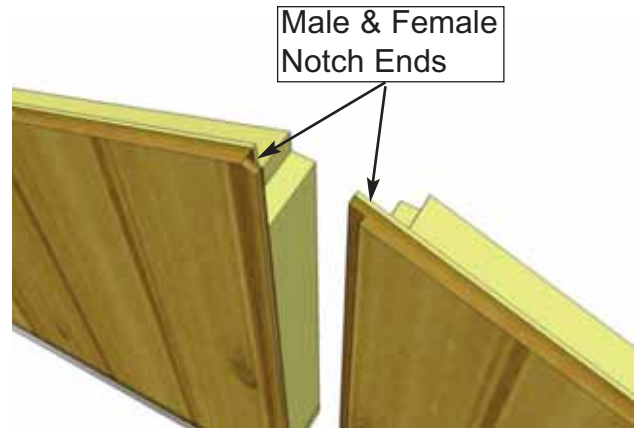
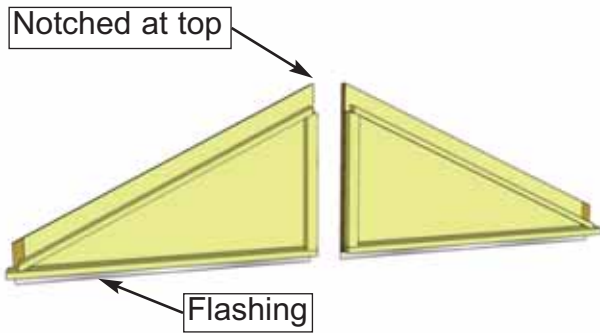

**29.** Locate **Gable 1/2 Walls** for both sides of shed. Align framing and gable lapp siding together. Screw center gable wall framing of each piece together with **3 - 2 1/2" screws**. Note: prior to attaching, try each combination of Gables for best fit.

Parts (Steps 29-32)  
**Gable Half Walls**  
 Triangular shaped x 4

Hardware (Steps 29-32)  
**S1 - 2 1/2" Screws**  
 x 6 total  
**S3 - 2" Screws**  
 x 4 total

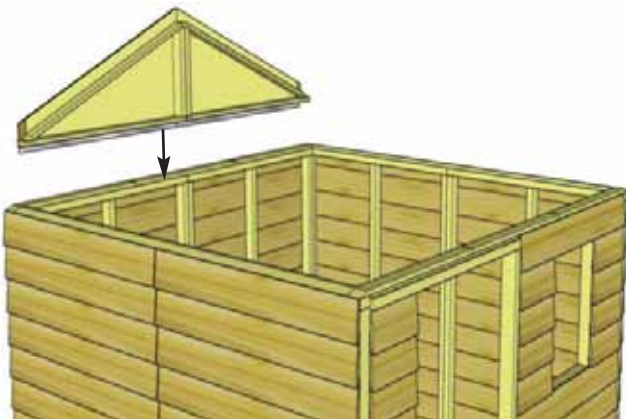

**30.** Lift up a completed gable section and place on top of Rear Top Plate on wall. The rear gable framing should sit flush with the inside of the top plate.

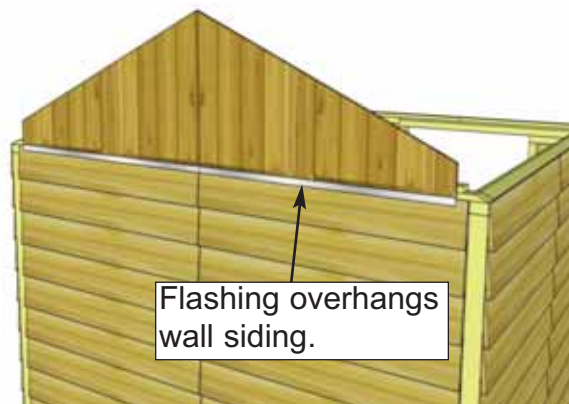
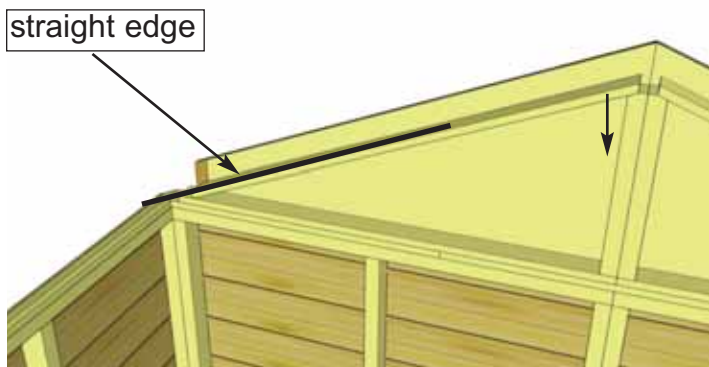

**31.** The gable should be centered sideways (left to right) on the top plate. **Hint:** use a straight edge to check the angle of the gable framing and top plate. Both angles should line up. Adjust gable accordingly. Temporarily attach Gable to walls to top plate with **2 - 2" screws**. Screw from the bottom of gable framing down into Top Plate and Wall. Gables may need slight adjustment in **Step 44** and then will be completely attached with an additional 6 - 2" screws.

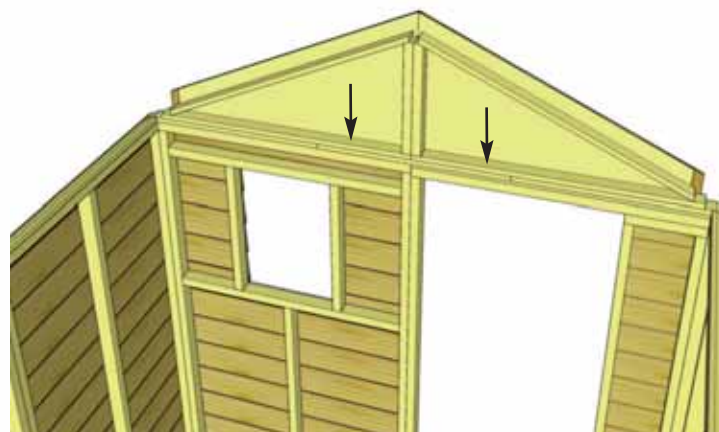

**32.** Complete positioning and attachment of front gable as per **Step 29-31**.



# C. Rafter and Roof Section

Exploded view of all parts necessary to complete the Roof Section.  
Identify all parts prior to starting.

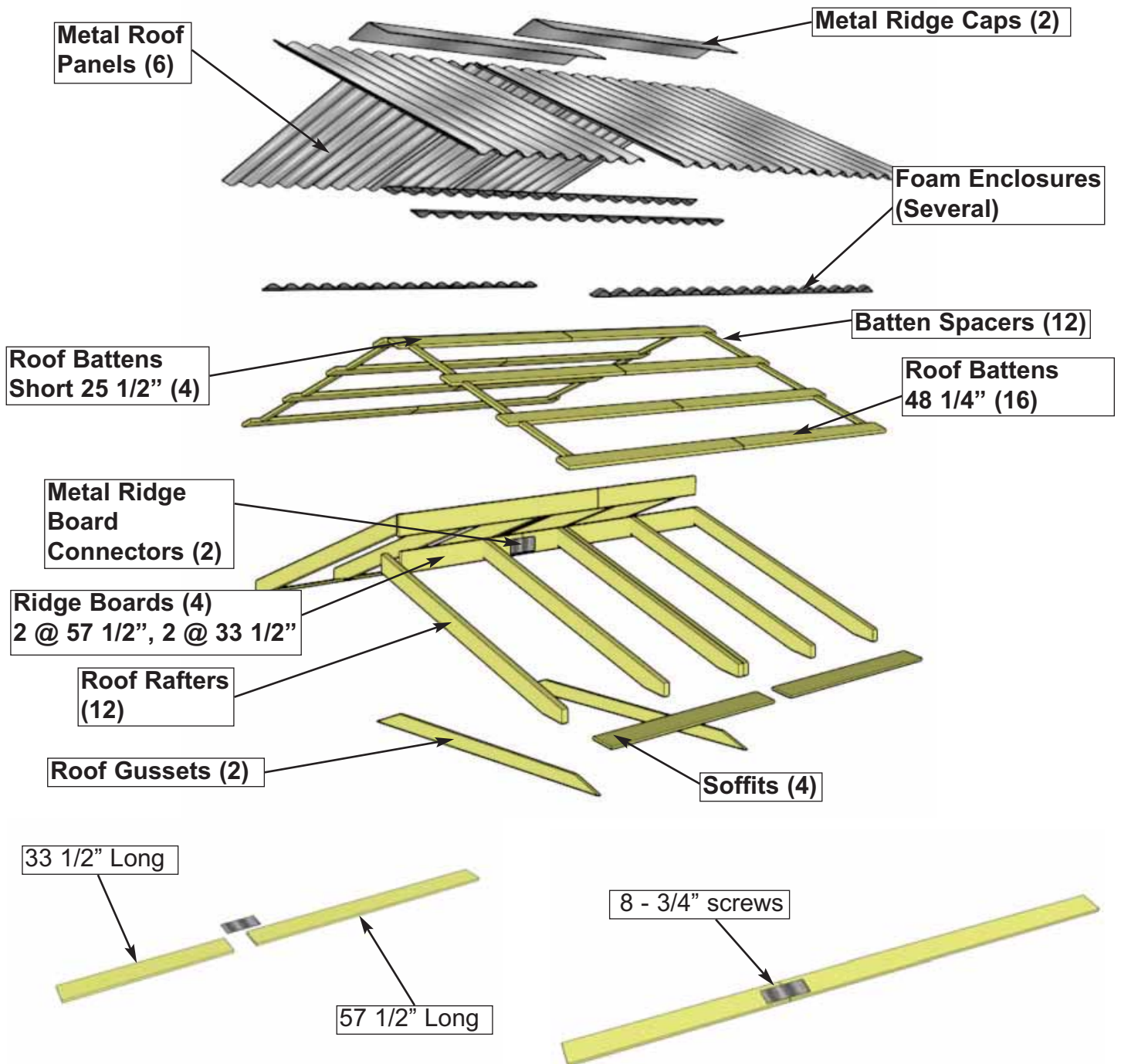

**33.** Locate **Ridge Boards** and attach together with **Metal Ridge Board Connector** using **8 - 3/4" screws**. Total Length when connected is 91". Complete two Sets. Position Metal Ridge Board Connector evenly on Ridge Boards.

**Parts (Step 33)**  
**Ridge Boards Long**  
 (3/4" x 4 1/2" x 57 1/2") x 2  
**Ridge Boards Short**  
 (3/4" x 4 1/2" x 33 1/2") x 2

**Hardware (Step 33)**  
**SS2 - 3/4" Screws**  
 x 16 total  
**Metal Ridge Board Connector**  
 x 2 total

**34.** Locate 6 **Rafters**, 2 **Soffits** and completed **Ridge Board** from **Step 33**. Lay out as illustrated on a flat level surface.

Parts (Step 34 - 42)

**Rafters**

(1 1/2" x 3 1/2" x 56 1/2")x 12

**Soffits**

(1/2" x 4 1/2" x 45 1/2")x 4

Hardware (Step 34 - 42)

**S1 - 2 1/2" Screws**

x 6 total

**S2 - 1 1/4" Screws**

x 48 total

**S3 - 2" Screws**

x 24 total

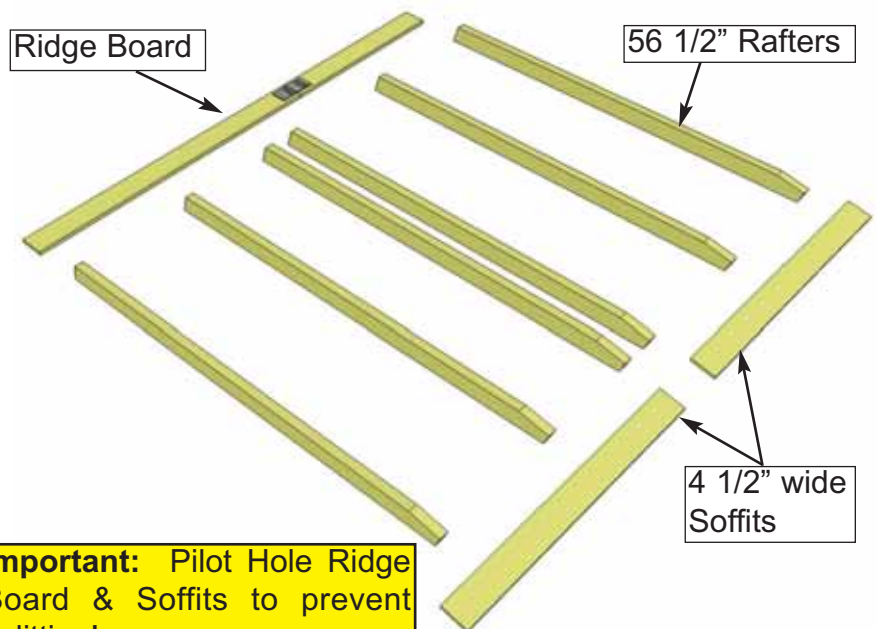

**Important:** Pilot Hole Ridge Board & Soffits to prevent splitting!

**35.** Attach end of a 45 1/2" long **Soffit Board** flush to ends of outside **Rafter** with 2 - 1 1/4" screws per Rafter end. **Drill pilot hole in Soffit ends to prevent splitting.** Attach **Ridge Board** to opposite rafter end with 2 - 2" screws, while aligning to bottom of rafter. Center **Soffit** on Doubled-up Rafters and secure with 2 - 2" screws. Measure 45 1/2" from outside rafter and secure Ridge Board to rafter with 2 - 2" screws. Attach Doubled-up Rafters together with 3 - 2 1/2" screws.

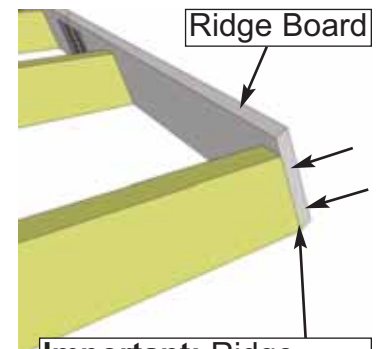

**Important:** Ridge Board must be aligned as illustrated.

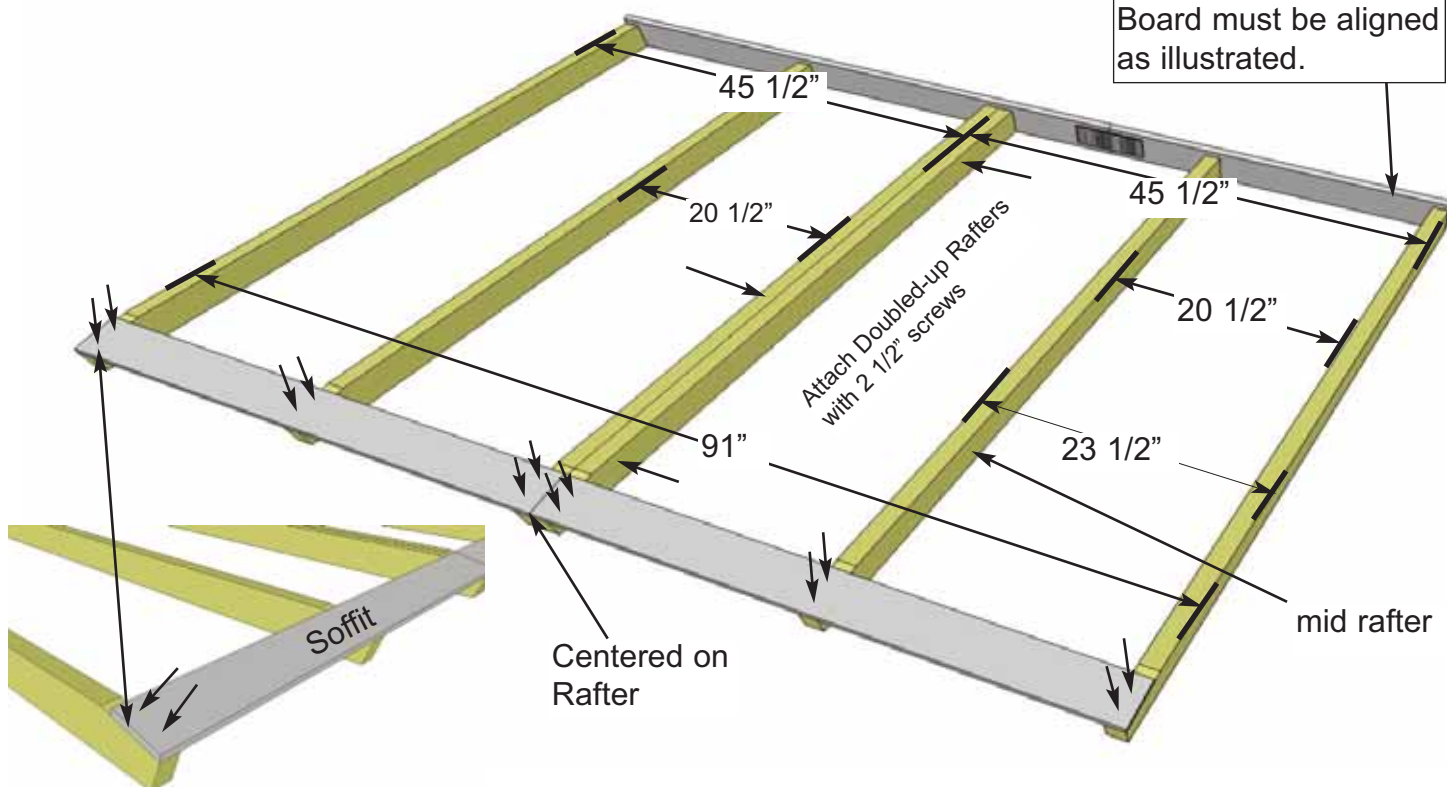

**36.** Measure, position and attach mid rafters as illustrated above as per **Step 35**.



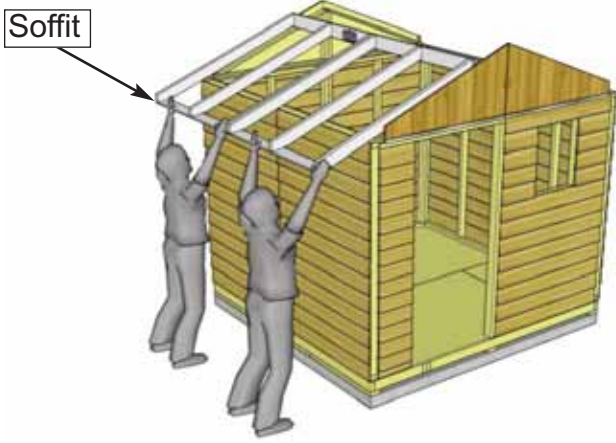

**37.** Flip Rafter Section over so Soffit is facing down. Starting with the left side, lift completed rafter section up and place on gable framing.

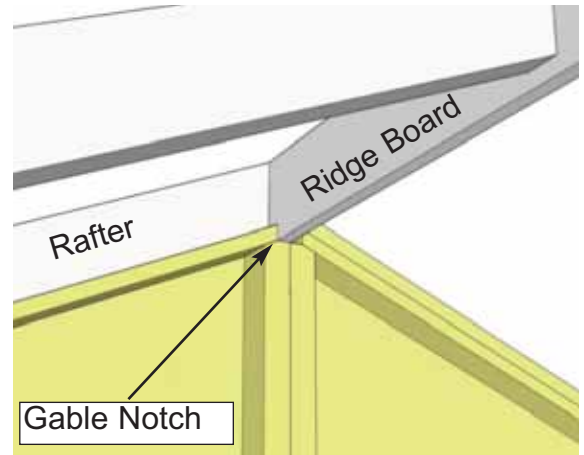

**38.** Slide Rafter Section up on gable framing until bottom of Ridge Board slips into gable notch.



**39.** When Rafter Section is correctly positioned, outside rafters will sit equally on gable framing and Soffit will sit approximately 1/8" away from wall panels.



Completed left side Rafters



**40.** Place 2nd completed Rafter Section on gable wall framing. Position as per **Steps 38 & 39.**



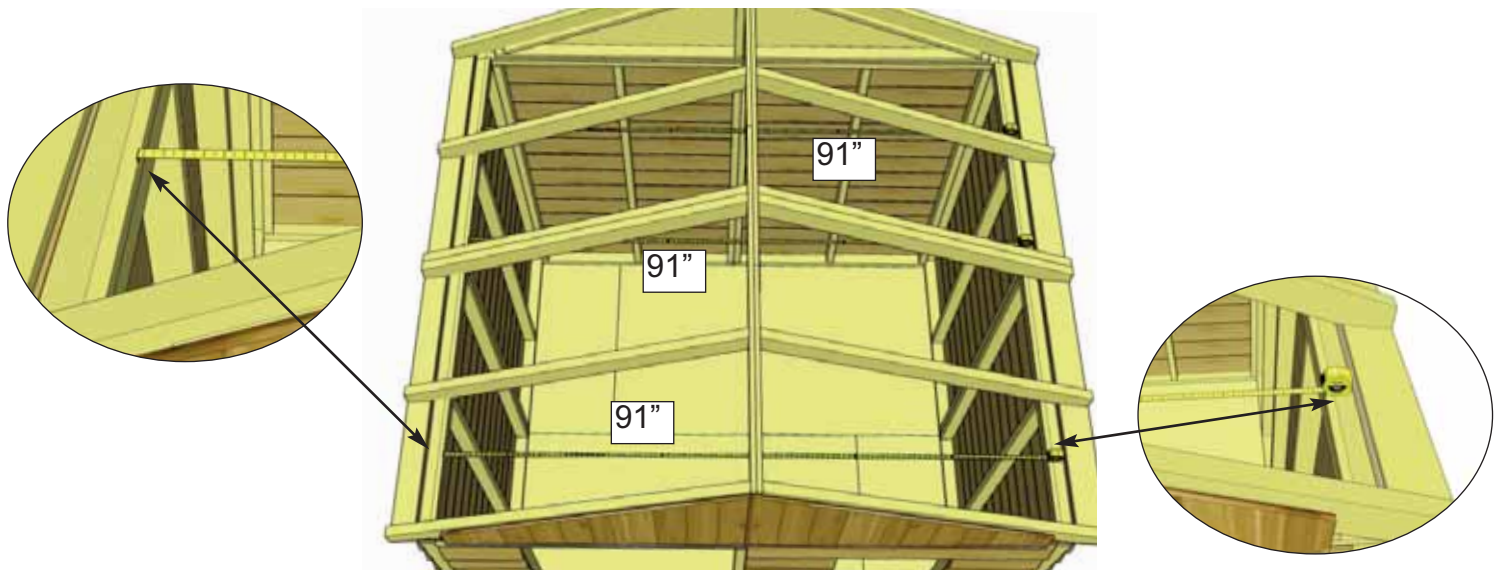

**41.** Take the inside - to inside measurement between **Top Wall Plates** and **Bottom Wall Plates** at the front middle and rear of your shed. These measurements should each be approximately 91", but more importantly, if they are not within 1/4" of each other than your walls are not square. Ensure walls are square before attaching **Ridge Boards** together in **Step 42**.

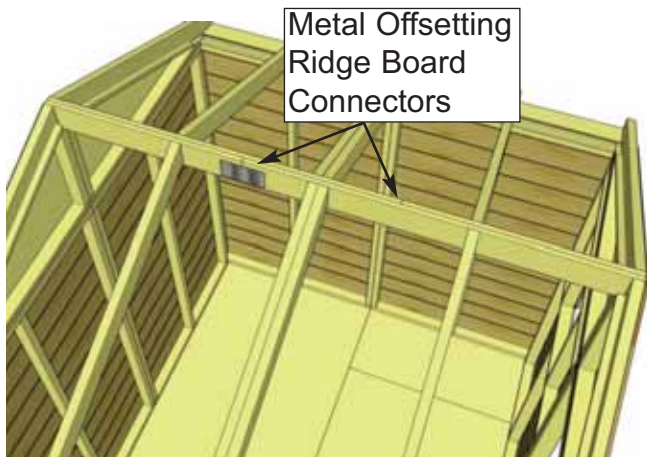

**Expert Advice:** It may be helpful to use some clamps to help hold Ridge Boards flush together while screwing.

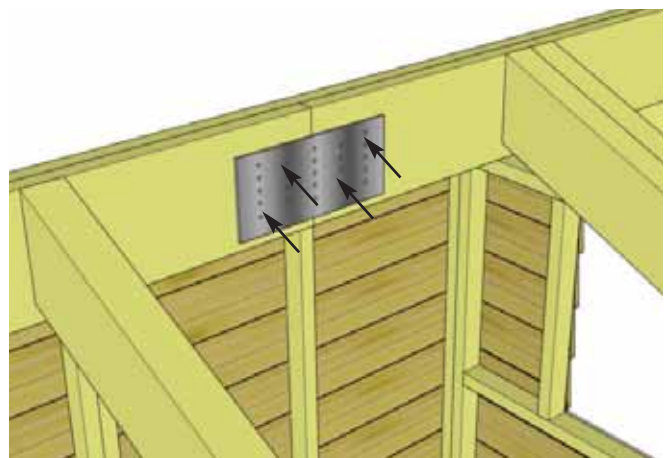
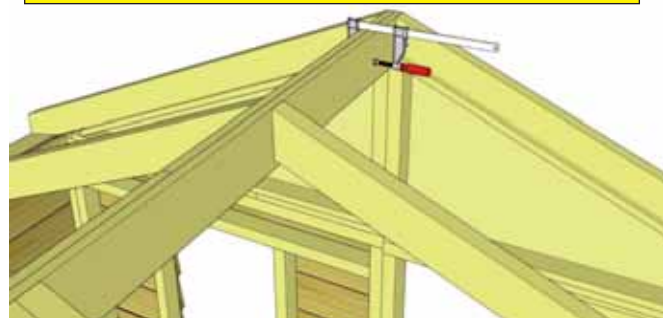

**42.** At the peak, align **Ridge Boards** so they are flush together and secure them with **8 - 1 1/4" screws**. To completely secure **Ridge Boards**, place **4 - 1 1/4" screws** into any of the remaining **Metal Ridge Board Connector** holes. Complete both sides. **Important:** if there is a gap between Ridge Boards, try pushing side walls closer together from outside. Walls should be 91" apart at top from inside of wall plate to wall plate.

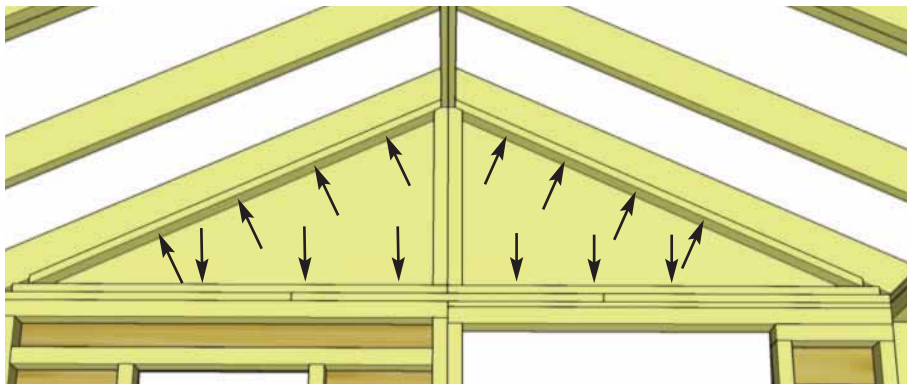

**43.** With both Ridge Boards connected, completely secure Gable framing to walls and rafters. Use **4 - 2" screws** per Rafter. Use an additional **6 - 2" screws** to secure Gable to wall. **Note: you may have to remove the 2 temporary screws in Gable from Step 32 and reposition Gable for best fit prior to completing gable attachment.**

Hardware (Step 43)  
**S2 - 1 1/4" Screws**  
 x 28 total

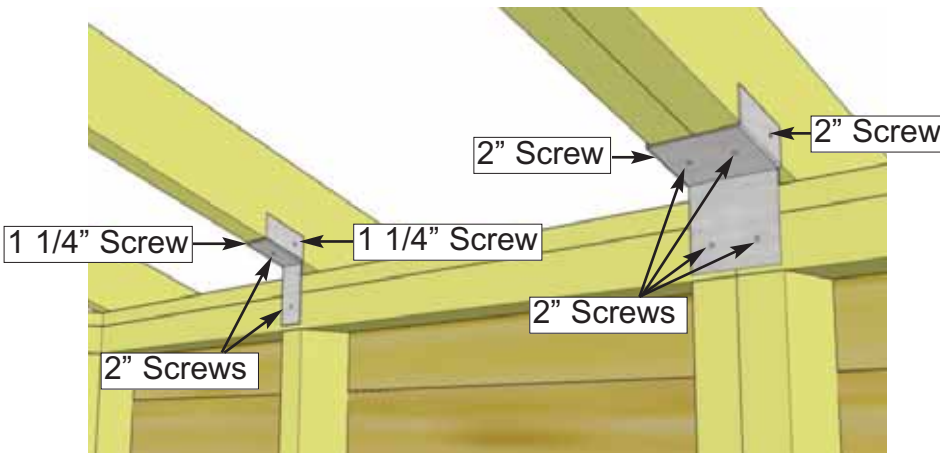

**44.** Attach all **Single and Double Rafter Brackets** where rafters meet **Top Wall Plates** inside of shed. Attach with **2 - 1 1/4" screws** and **2 - 2" screws** per **Single Bracket** and **6 - 2" screws** per **Double Bracket**.

Hardware (Step 44)

**S2 - 1 1/4" Screws**

x 8 total

**S3 - 2" Screws**

x 20 total

**Y30 - Single Rafter Brackets**

x 4 total

**Y31 - Double Rafter Brackets**

x 2 total

**Expert Advice:** While securing Roof Gussets have two helpers push the side walls together so the inside measurement remains 91" across as per **Step 41**.

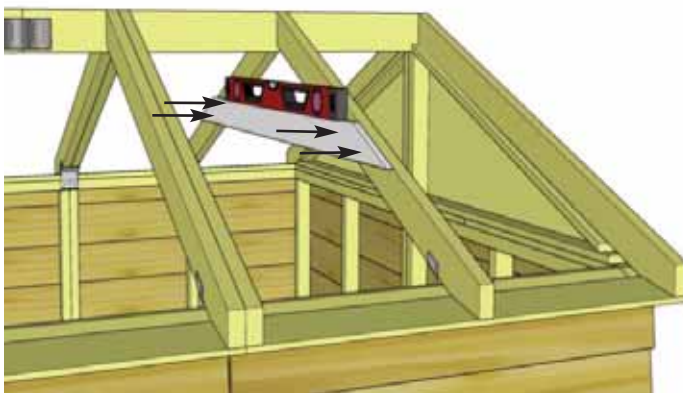

**45.** **Roof Gussets** are positioned on both mid **Rafters**. Slide **Gusset** up, use a level to square **Gusset** and attach to **Rafters** with **4 - 2" screws**. Pilot hole each **Gusset** end with 1/8" drill bit. Complete remaining **Gusset**.

Parts (Steps 45)

**Gussets**

(3/4" x 3 1/2" x 72") x 2  
 (angle cut on ends)

Hardware (Steps 45)

**S3 - 2" Screws**

x 8 total



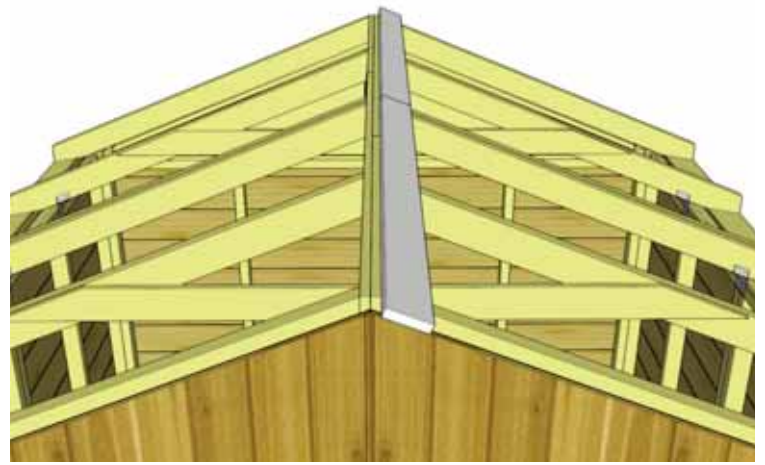

**46.** Locate **2 Roof Battens** and place one of each on roof rafters. Place at top of **Rafter** section where **Rafter** and **Ridge Boards** meet. **Battens** should be positioned evenly on 3rd rafter. **Battens** will overhang outside **Rafter** by 2 3/4".

Parts (Step 46)  
**Roof Battens**  
 (3/4" x 3 1/2" x 48 1/4") x 2

Hardware (Step 46)  
**S2 - 1 1/4" Screws**  
 x 6 total

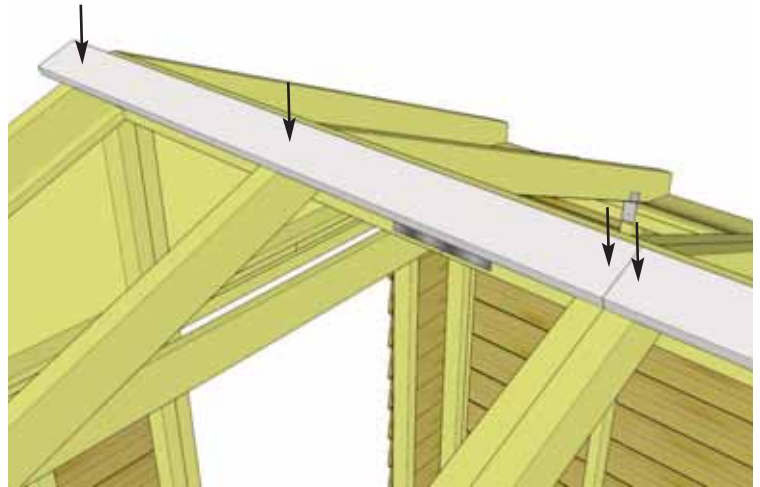
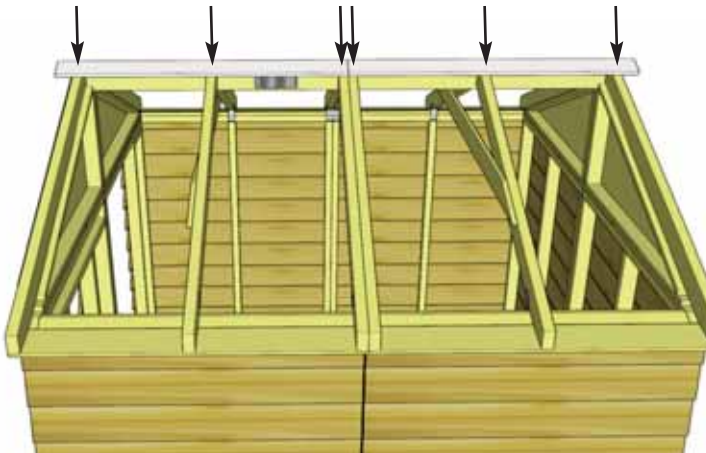

**47.** Attach Battens to each Rafter. For each **Batten** use **3 - 1 1/4" screws**.

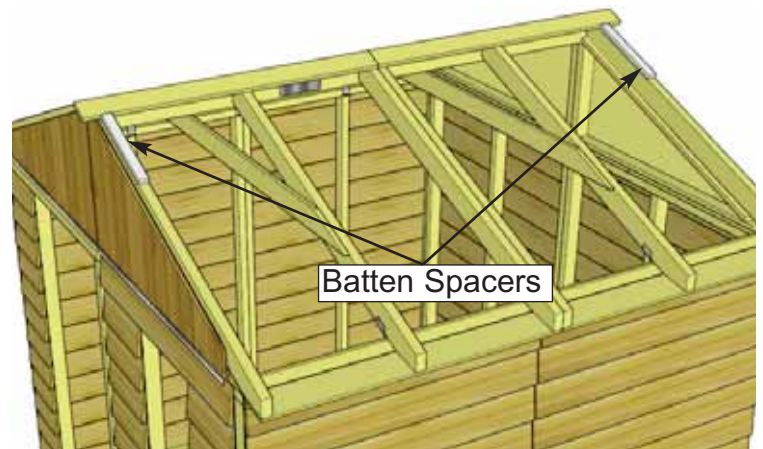
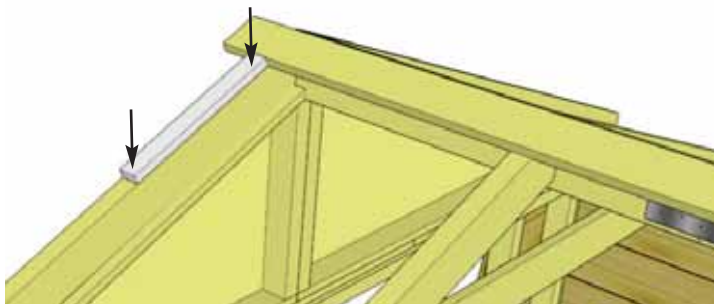

**48.** Locate **Batten Spacers**. Place 1 **Batten Spacer** below each **Batten** lengthwise along outside **Rafter**. Attach each **Batten Spacer** to outside **Rafter** with **2 - 1 1/4" screws** (4 total).

Parts (Step 48)  
**Batten Spacer**  
 (3/4" x 1 1/2" x 14") x 2

Hardware (Step 48)  
**S2 - 1 1/4" Screws**  
 x 4 total



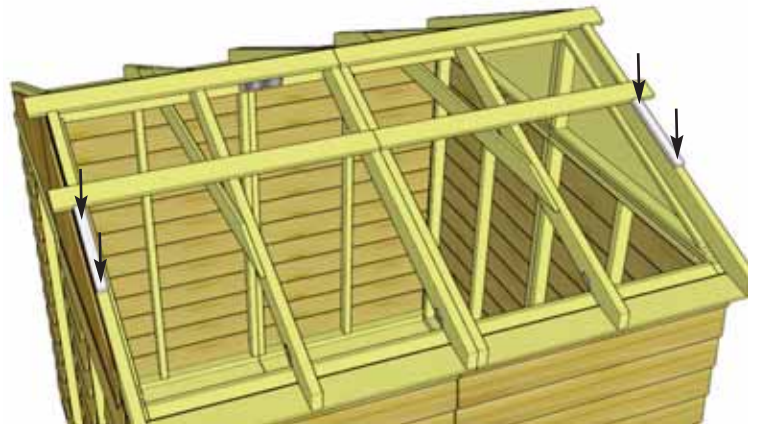
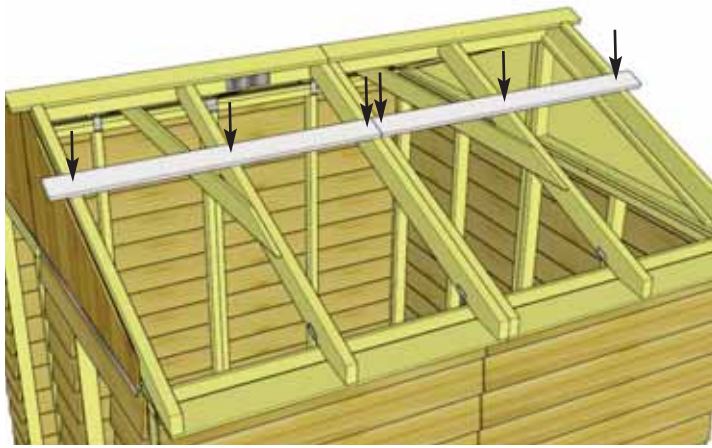

**49.** Locate 2 more **Roof Battens**. Place both Battens flush against **Batten Spacers** installed in **Step 48**. Battens will overhang outside **Rafter** by 2 3/4" and meet on doubled up **Rafters** in the center. Attach **Battens** with **3 - 1 1/4" screws** each (6 total). Locate 2 more **Batten Spacers** and attach below 2nd row of **Battens** as per **Step 48**.

Parts (Step 49)  
**Roof Battens**  
 (3/4" x 3 1/2" x 48 1/4") x 2  
**Batten Spacers**  
 (3/4" x 1 1/2" x 14") x 2

Hardware (Step 49)  
**S2 - 1 1/4" Screws**  
 x 10 total

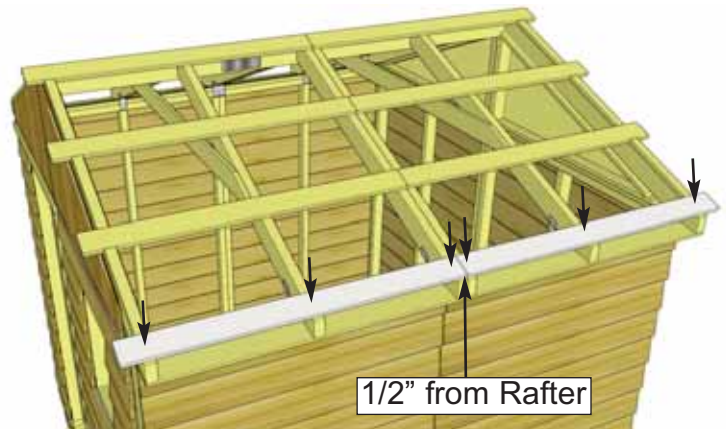
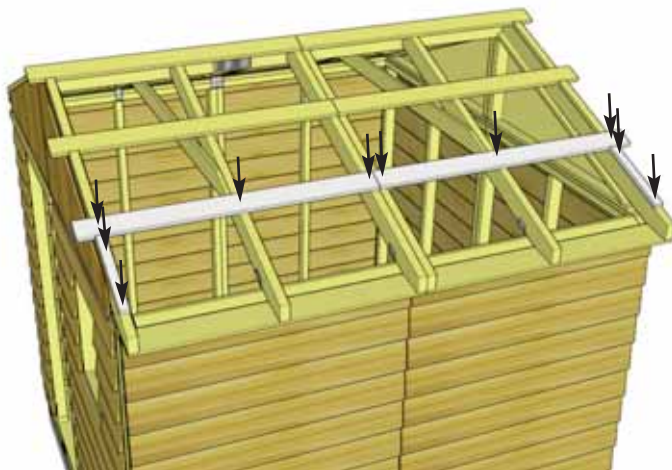

**50.** Attach 3rd row of Battens (**1 Roof Batten Long & 1 Roof Batten Short**) as per **Step 47**. Have the seam between **Battens** in the 3rd row on the opposite side as the first. Attach the final pair of **Batten Spacers** for this side following the 3rd row as per **Step 48**. Attach final row of **Battens (2 Roof Battens Center)** below the 3rd spacer. Final row of **Battens** should land 1/2" from end of **Rafter**.

Parts (Step 50)  
**Roof Battens**  
 (3/4" x 3 1/2" x 48 1/4") x 4  
**Batten Spacers**  
 (3/4" x 1 1/2" x 14") x 2

Hardware (Step 50)  
**S2 - 1 1/4" Screws**  
 x 16 total

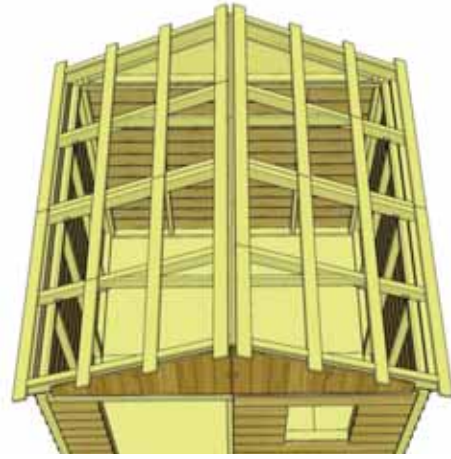
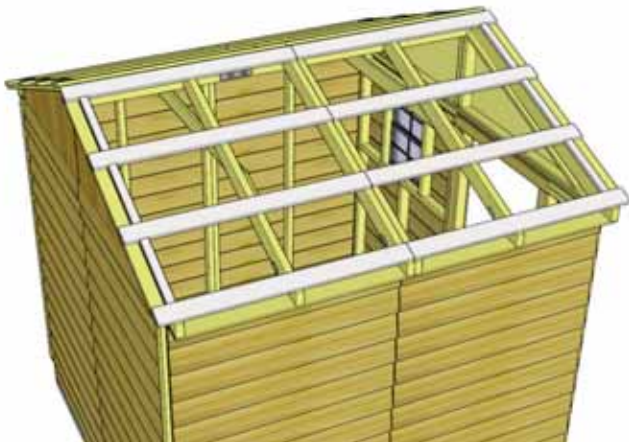

**51.** To complete opposite side of roof repeat **Steps 46 - 50.**

Hardware (Step 51)  
**S2 - 1 1/4" Screws**  
 x 36 total

Parts (Step 46)  
**Roof Battens**  
 (3/4" x 3 1/2" x 48 1/4") x 8  
**Batten Spacers**  
 (3/4" x 1 1/2" x 14") x 6

**Important:** Do not fasten down Metal Roof Panels with Hangers still in place. Metal Roof Hangers will temporarily help keep Metal Roof Panels in place before they are fastened.

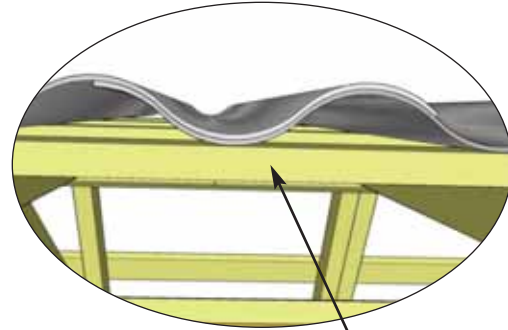
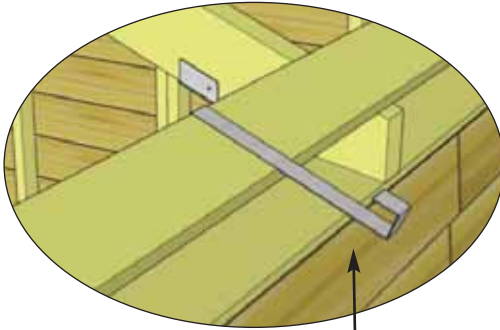

**52.** Locate 3 **Metal Roof Panels** and 3 **Metal Roof Hangers**. To temporarily hold the **Metal Roof Panels** in place, hook a **Metal Roof Hanger** onto the lowest **Batten**, approximately where the center of the panels will be. Place first **Metal Roof Panel** on Battens and into Hanger. Do not fasten panels down until **Step 57**. Place remaining 2 panels and hangers on the same way. **Metal Roof Panels** will overlap each other.

Parts (Step 52)  
**Metal Roof Panels**  
 (39" wide x 61" long) x 3  
Hardware (Step 52)  
**Y38 - Metal Roof Hangers**  
 x 3



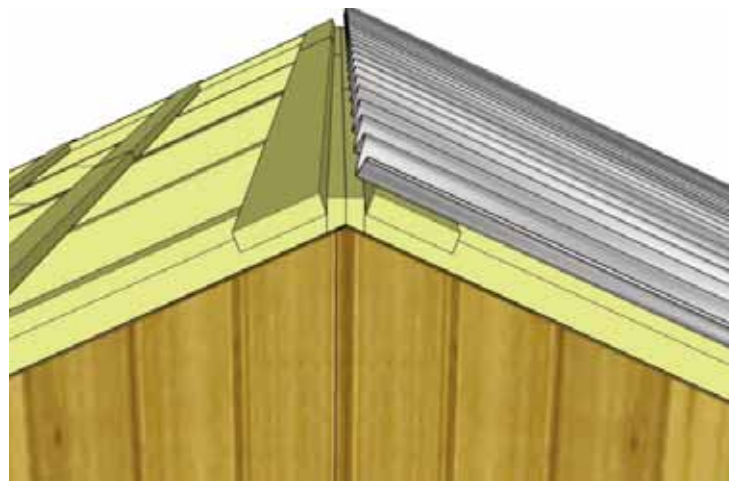

**53.** Overhang the **Metal Roof Panels** past the **Battens** on sides approximately 1". Adjust panels side-to-side to achieve desired width. Overall width past the **Battens** can vary from 1" - 3" depending on your preference. The overhang over the side of the shed will be set by the **Metal Roof Hangers**, but should be approximately 4" on the side of shed.

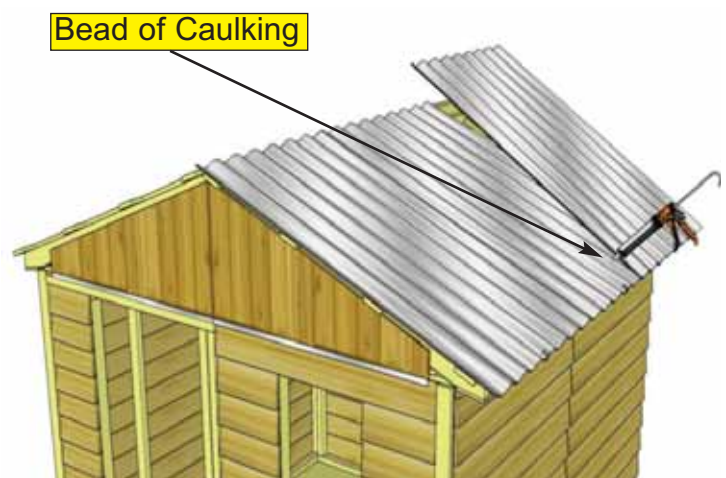
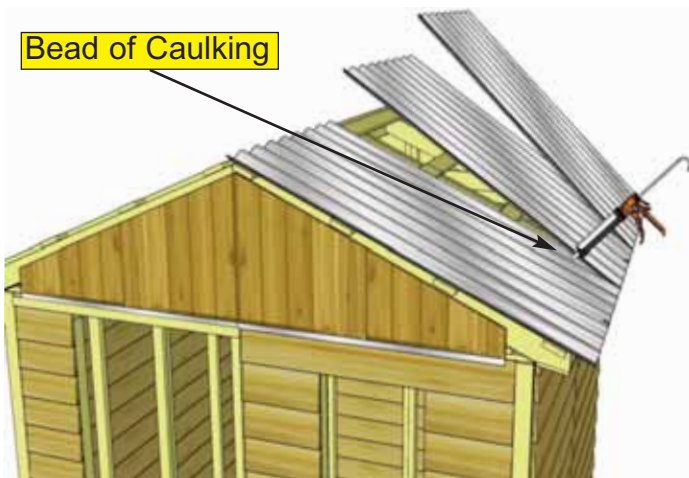

**54.** Once the Metal Roof is spaced correctly from side-to-side and top-to-bottom, lift 2 panels up and run a bead of caulking down the overlapping seams of each panel to seal the joints, Place panels down one by one once seam is caulked. You will likely need assistance from a helper for this step. Caulk each seam.

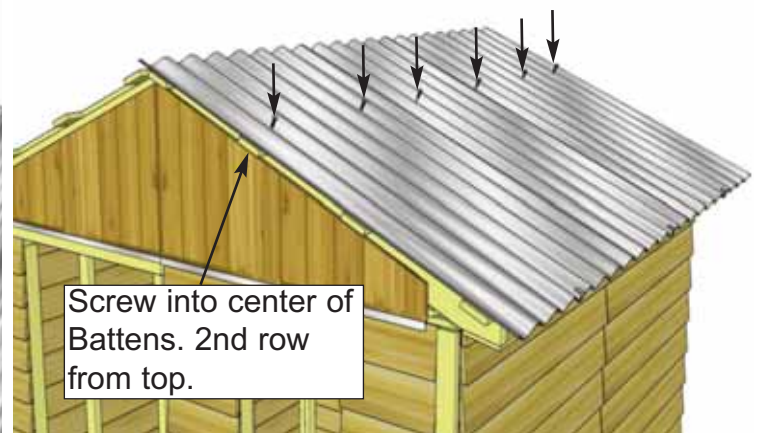

**55.** Using **6 - 2" Metal Screws** and 1/4" Nut Driver (included), partially secure **Metal Roof Panels** to 2nd row of **Battens** from top. Only fasten screws halfway so that **Metal Roof Hangers** can be removed. Metal screw is self-tapping, screw into center of Battens.

Hardware (Step 55)  
**2" - Metal Roof Screws**  
 x 6



**Important: Remove Metal Roof Hangers**

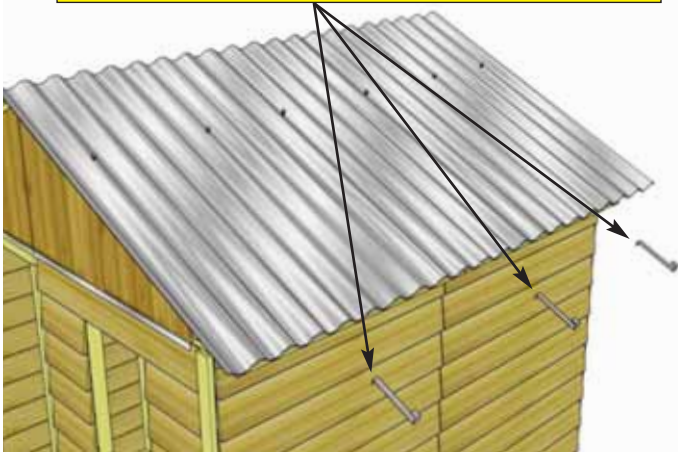

**56.** Before fully fastening **Metal Roof Panels** down, remove the **Metal Roof Hangers** and insert **Foam Enclosures** between **Metal Roof Panels** and **Battens** at the bottom of the roof. Enclosures will prevent moisture and unwanted bugs, etc from entering your shed through here.

Parts (Step 56)  
**Foam Enclosures**  
(Several Pcs)

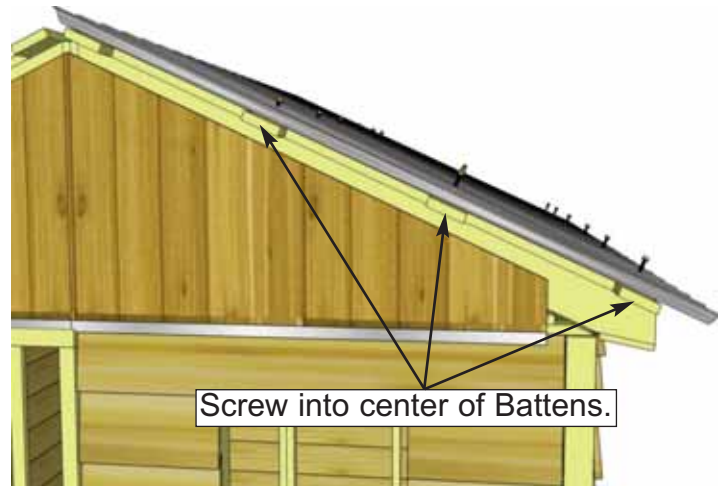
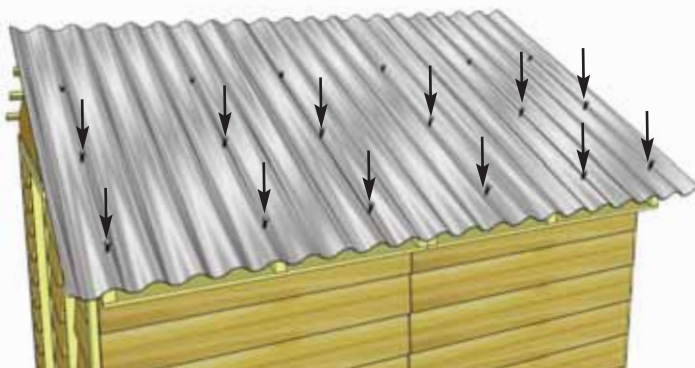

**57.** Using **12 - 2" Metal Screws** and 1/4" Nut Driver, secure **Metal Roof Panels** down to lower 2 rows of **Battens**. Leave the top row unsecured for now to secure Ridge Cap to later in **Step 60**. Tighten screws in middle row that were partially attached in **Step 55**. Do not Overtighten!

Hardware (Step 57)  
**2" - Metal Roof Screws**  
x 12

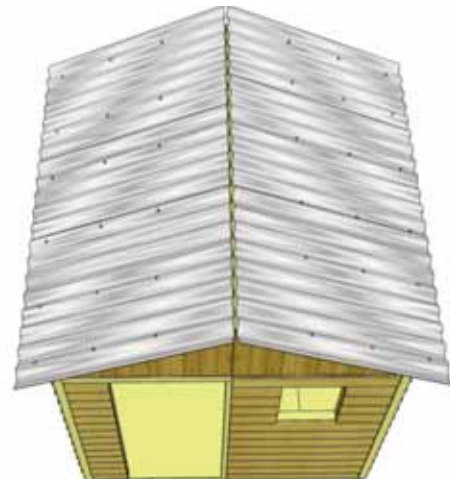

**58.** Repeat **Steps 52 - 57** to complete opposite side of roof.

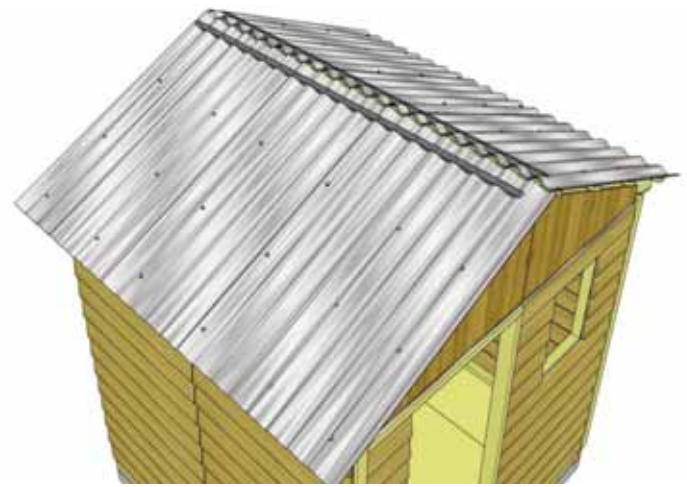

**59.** Locate remaining Foam Enclosures. Place Foam Enclosures at the top of the roof panels. Foam Enclosures prevent moisture from coming in through the top of your shed.

Parts (Step 59)  
**Foam Enclosures**  
 (Several Pcs)



**60.** Place 2 **Metal Ridge Caps** onto apex of roof. Evenly space from front to back of your shed Caps will overlap each other. Overhang the cap approximately 1" - 2" past each end. When **Metal Ridge Caps** are correctly positioned, secure with **12 - 2" Metal Roof Screws** (6 per side). Screw into center of final **Batten**. Do not overtighten!

Parts (Step 60)  
**Metal Edge Caps**  
 (60" long) x 2  
Hardware (Step 60)  
**2" - Metal Roof Screws**  
 x 12



# D. Miscellaneous Section

Exploded view of all parts necessary to complete the Miscellaneous Section. Identify all parts prior to starting.

**Not Shown:** missing from exploded drawing: Interior Door Stops, Top Wall Trim.

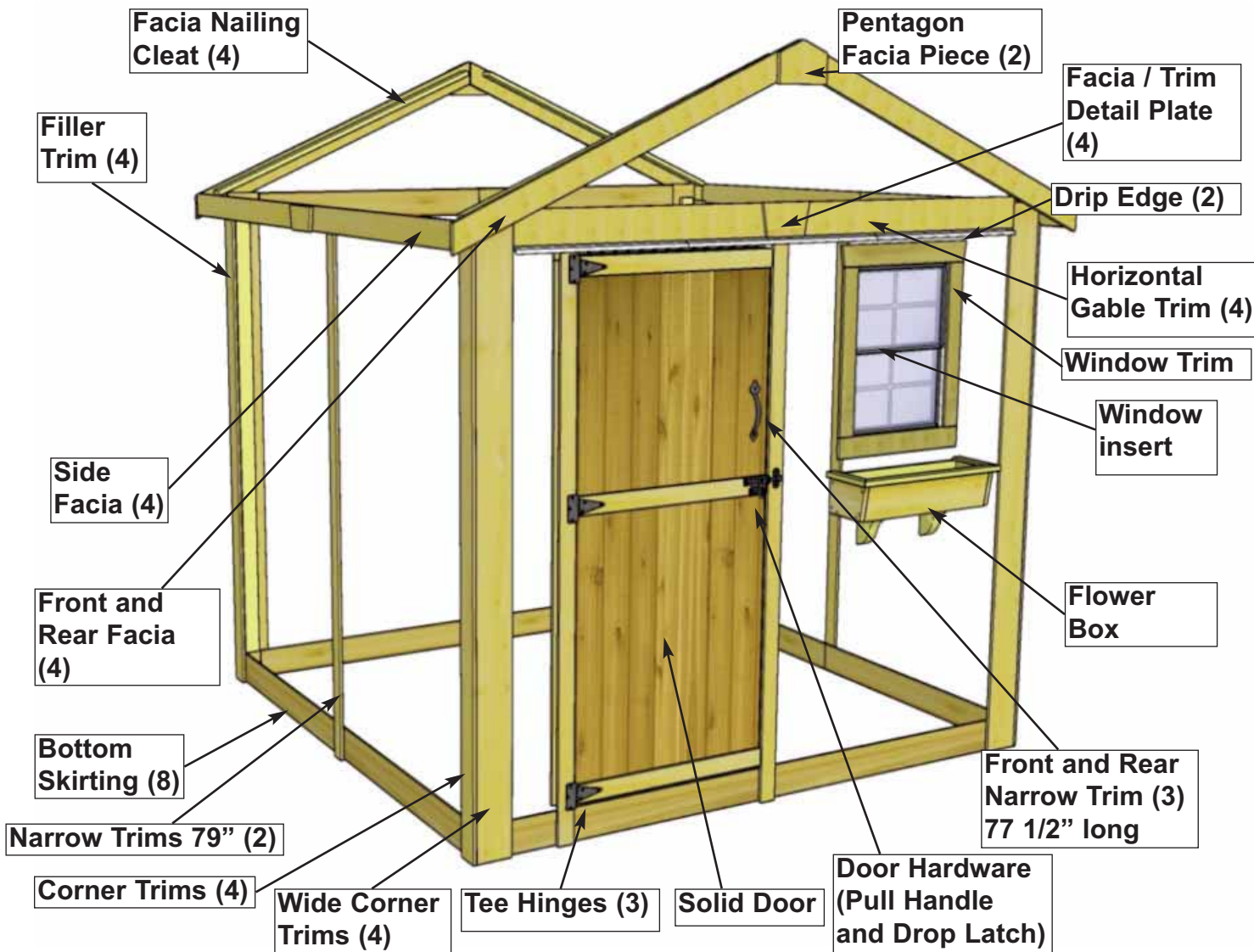

2 pieces of Bottom Skirting for front and rear. 2 pieces for sides.

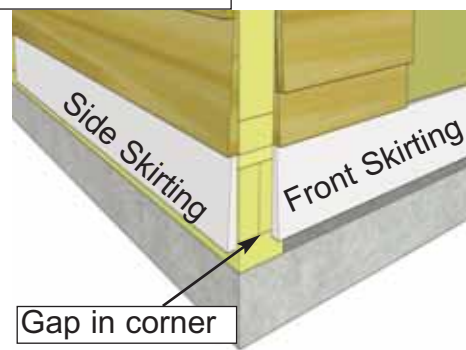

Gap in corner

**61.** Attach **Bottom Skirting (Bevel)** around the base of the shed. Bevel is thicker at bottom of board than the top. Skirting will hide floor framing. The side skirting pieces will meet together in the center. Gaps on outside will be covered by Wide Trim pieces later. Start side skirting pieces first then rear, then front skirting pieces last and attach with **4 - 1 1/2" finishing nails** per piece.

**Parts (Steps 61)**  
**Bottom Skirting - Bevel**  
 (3/4" x 4 1/2" x 45 1/4") x 8  
**Hardware (Steps 61)**  
**N1 - 1 1/2" Screws**  
 x 32 total



**Expert Advice:** When installing trim, sort pieces according to color and pieces that are most pleasing to the eye. Start with least visible side and use the least desirable pieces first. Install trim to most visible sides as your skill installing trim improves.

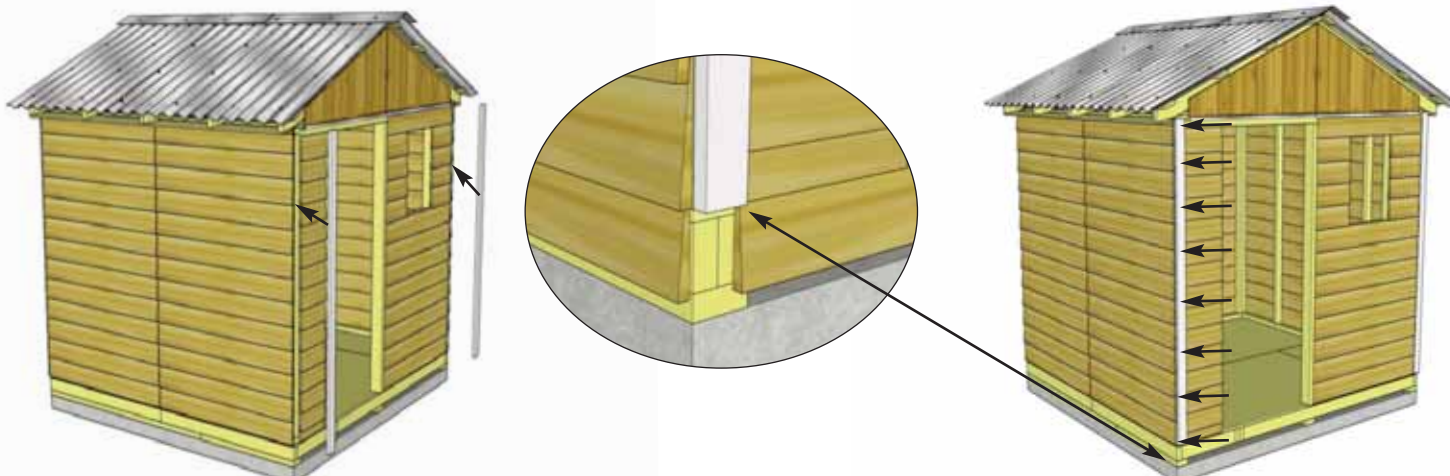

**62.** Attach **Filler Trims** to each corner side wall. Align Filler Trim so it sits flush with the bottom of the last piece of Wall siding. Attach with **8 - 1 1/2" Finishing Nails** per piece.

Parts (Steps 62)  
**Filler Trims**  
 (7/8" x 2 1/2" x 75") x 4

Hardware (Steps 62)  
**N1 - 1 1/2" Finishing Nails**  
 x 32 total



**63.** Trim out Side Walls by attaching **Top Wall Trim**. Position with thick end of Bevel downward at top wall, tight against Soffits. Attach with **4 - 1 1/2" Finishing Nails** per piece.

Parts (Steps 63)  
**Top Wall Trim**  
 (3/4" x 1 1/2" x 45 1/4") x 4

Hardware (Steps 63)  
**N1 - 1 1/2" Finishing Nails**  
 x 32 total

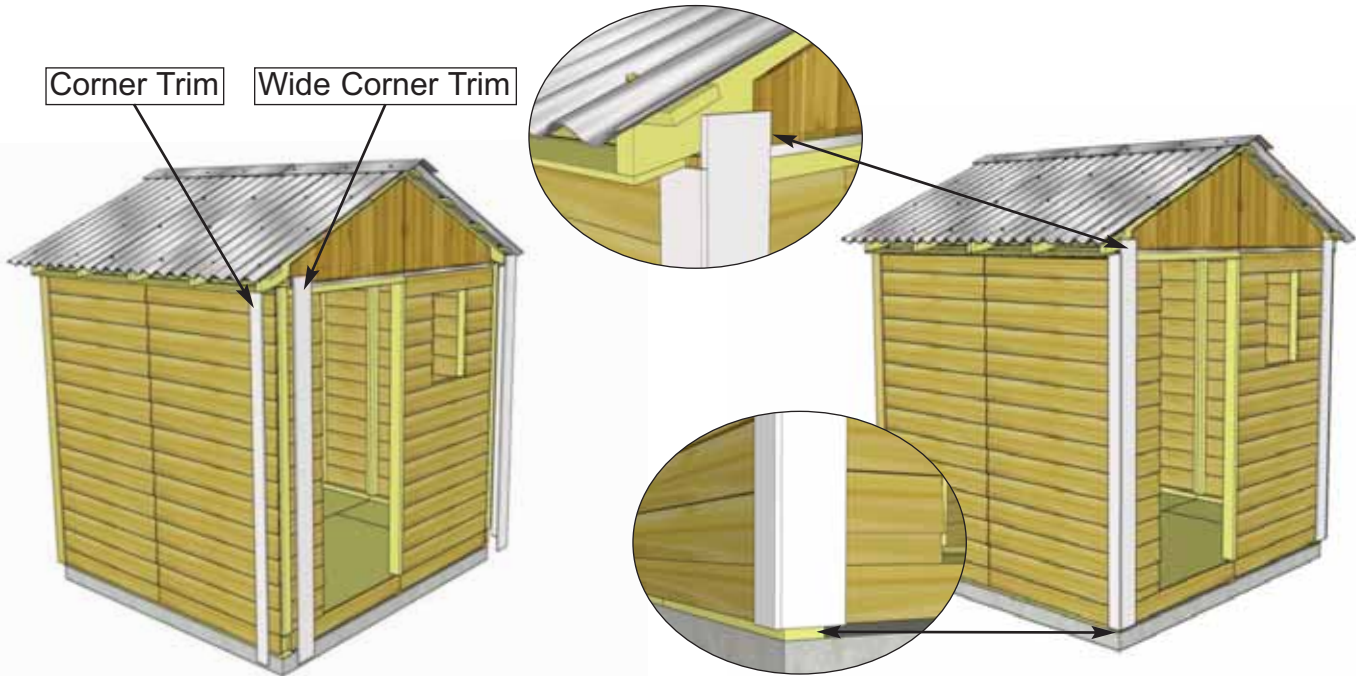

**64.** To trim out corners, start with **Narrow Trim**, align tight underneath **Soffit** and **Rafter**. Align **Wide Corner Trim** with bottom of **Corner Trim**. Do a dry run in each corner before attaching to confirm positioning. Use **8 - 1 1/2" Finishing Nails** per piece to secure. Complete other front corner as above.

Parts (Steps 64 - 65)

**Corner Trim**

(1/2" x 3 1/2" x 79") x 4

**Wide Corner Trim**

(1/2" x 5 1/2" x 82") x 4

Hardware (Steps 64 - 65)

**N1 - 1 1/2" Finishing Nails**

x 64 total

**65.** Trim out rear corners with remaining pieces of **Corner Trim** and **Wide Corner Trim**. Align and attach with **8 - 1 1/2" Finishing Nails** per piece as per **Step 64**.



**66.** Attach **Rear Horizontal Gable Trim** to the back of shed. Position over gable and wall seam with thick end of Bevel downward. Use **5 - 1 1/2" Finishing Nails** to secure each piece.

Parts (Steps 66)

**Rear Horizontal Gable Trim - Bevel**

(3/4" x 4 1/2" x 43 3/8") x 2

Hardware (Steps 66)

**N1 - 1 1/2" Finishing Nails**

x 10 total





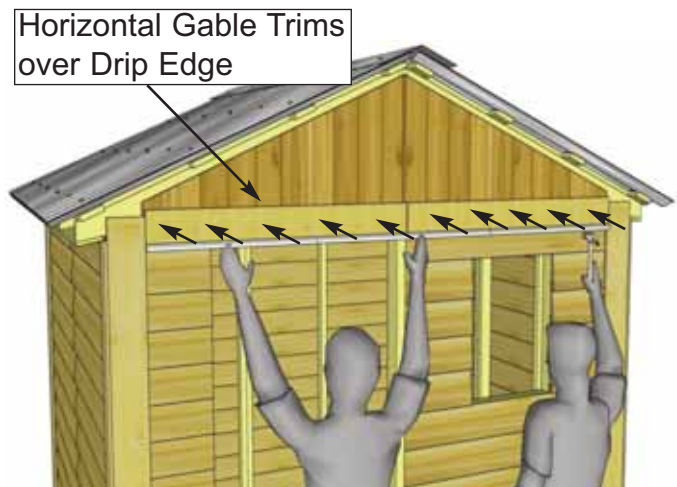

**67.** Position **Drip Edges** so they are overlapping each other above doorway flush with **Wide Corner Trims**. With **Drip Edges** in place, place Front **Horizontal Gable Trims** over top of **Drip Edges**. Attach both with **10 - 1 1/2" Finishing Nails**.

Parts (Steps 67)  
**Horizontal Gable Trim**  
 (1/2" x 4 1/2" x 43 3/8") x 2  
**Drip Edges**  
 (60" long) x 2

Hardware (Steps 67)  
**N1 - 1 1/2" Finishing Nails**  
 x 10 total



**68.** Attach **Side Wall Narrow Trims** where wall panels come together and leave a seam. Position trim equally on wall seam and tight underneath Soffit and Rafters. Use **8 - 1 1/2" Finishing Nails** per piece to secure. Complete both sides of shed.

Parts (Steps 68)  
**Side Wall Narrow Trim**  
 (1/2" x 2 1/2" x 79") x 2  
Hardware (Steps 68)  
**N1 - 1 1/2" Finishing Nails**  
 x 16 total





**69.** Attach **Rear Wall Narrow Trims** where wall panels come together and leave a seam. Position trim equally on wall seam and tight underneath Horizontal Gable Trim. Use **8 - 1 1/2" Finishing Nails** to secure.

<p><u>Parts (Steps 69-70)</u>  <b>Rear/Front Wall Narrow Trim</b>          (1/2" x 2 1/2" x 77 1/2") x 3</p>
<p><u>Hardware (Steps 69-70)</u>  <b>N1 - 1 1/2" Finishing Nails</b>          x 24 total</p>



**70.** Position the 2 remaining **Narrow Trim** pieces flush with inside of door jamb and Horizontal Gable Trim. Attach trim with **8 - 1 1/2" Finishing Nails** per piece.



**71** Attach **Facia Nailing Strips** to the underside edge of the Battens with **4 - 1 1/2" screws** per piece. **Nailing Strip** will make it easier to attach Front and Rear Facia in **Step 72**. Complete Front and Rear Strips (4 pieces total).

<p><u>Parts (Steps 71)</u>  <b>Facia Nailing Strips</b>          (3/4" x 2 1/2" x 52 1/2") x 4</p>
<p><u>Hardware (Steps 71)</u>  <b>S2 - 1 1/4" Screws</b>          x 16 total</p>

**72.** Position **Rear Facia** (angle cut ends) and **Side Facia** (square cut ends) in corner. Line up so angle cut Facia caps square cut Facia. Attach angled Facia to **Nailing Strip** with **8 - 1 1/2" Finishing Nails** per piece. Gap Where Facia boards come together at peak will be covered by a detail plate in **Step 72**. Do a dry run using **Side Facia** to help you correctly position before attaching.



Square Cut Facia

Angle Cut Facia

Parts (Steps 72 - 73)	Hardware (Steps 72 - 73)
<b>Angle Cut Facia</b> (3/4" x 3 1/2" x 58") x 4	<b>N1 - 1 1/2" Finishing Nails</b> x 64 total
<b>Square Cut Facia</b> (3/4" x 3 1/2" x 49 1/4") x 4	



**73.** Attach remaining **Front & Rear Facia** as per **Step 72** and attach **Side Facia** to Rafter ends. There are 2 Facia pieces per side. Secure with **8 - 1 1/2" Finishing Nails** per piece, ensure nails connect with the ends of the Rafters behind the Facia. Gaps between Facia pieces will be covered by Detail Plates in **Step 74**.

**74.** Attach **Pentagon Facia Plates** where Front & Rear Facias meet at the peak. Secure with **4 - 1 1/2" Finishing Nails** per piece. Attach **Facia Detail Plates** to cover seams where Side Facia Pieces meet. Secure with **4 - 1 1/2" Finishing Nails** per piece. Attach **Horizontal Gable Detail Plates** to cover seams where Horizontal Gable Trims meet. Secure with **4 - 1 1/2" Finishing Nails** per piece.

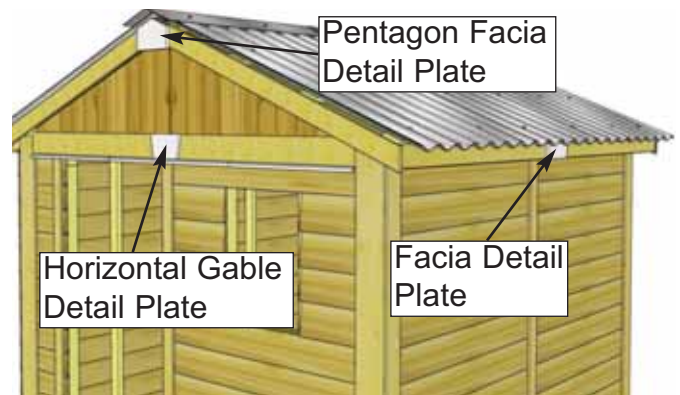

Parts (Steps 74)	Hardware (Steps 74)
<b>Pentagon Facia Plate</b> (1/2" x 5 1/2" x 8") x 2	<b>N1 - 1 1/2" Finishing Nails</b> x 24 total
<b>Facia Detail Plates</b> (1/2" x 3 1/2" x 8") x 2	
<b>Horizontal Gable Plates</b> (1/2" x 4 1/2" x 8") x 2	



**75.** Attach **Door Hinges** to **Door Panel** as shown above. Position Hinges equally on Door Trim as shown above and attach with **1 - 3/4" Black Screw** and **2 - 2" Black Screws** per hinge.

Parts (Steps 75)

**Door**

(31 1/2" x 72") x 1

Hardware (Steps 75)

**SB1 - 3/4" Black Screws**

x 3 total

**SB2 - 2" Black Screws**

x 6 total

**Y1 - Tee Hinges**

x 3 total

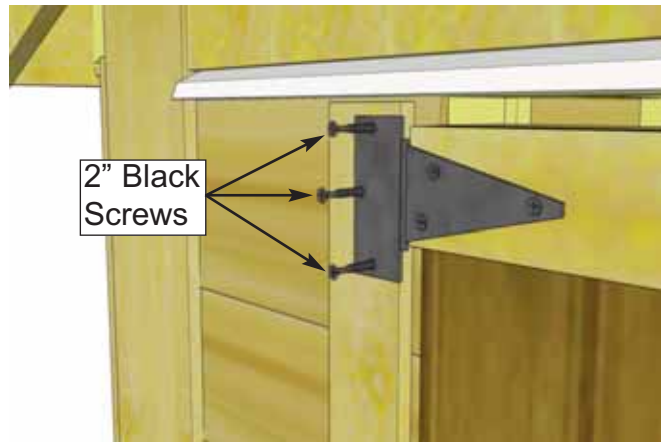
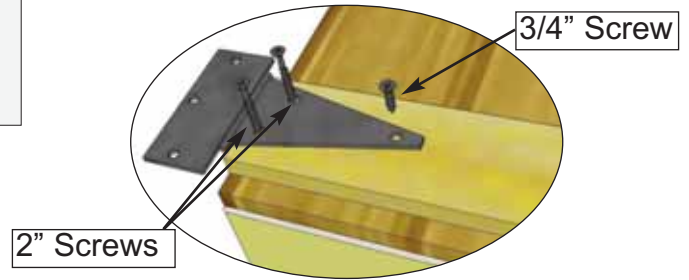

**76.** Place into position, gap 3/8" on bottom and evenly spaced on sides. Attach hinges to Narrow Trims with **3 - 2" Black Screws** per hinge. Use shim to help keep the door evenly spaced on bottom. Door Panel should be positioned so there is a 1/4" gap at top. Use a shim once again to help you position door correctly, attach remaining hinges.

Hardware (Steps 76)

**SB2 - 2" Screws**

x 9 total



**77.** Attach **Black Drop Latch** and **Black Handle** as illustrated above. Attach the **Black Drop Latch** with **4 - 2" Black Screws** & **1 - 3/4" Black Screw**. Note how female part of Drop Latch is positioned higher than male. Do a dry run first to position Drop Latch correctly. Attach **Door Handle** with **2 - 3/4" Black Screws**. **Important:** Drill pilot holes with 1/8" drill bit prior to securing to prevent wood from splitting. On 3/4" screw drill a shallow pilot hole.

Hardware (Steps 77)  
**Y3 - Black Handle**  
 x 1 total  
**Y5 - Black Drop Latch**  
 x 1 total  
**SB1 - 3/4" Black Screws**  
 x 3 total  
**SB2 - 2" Black Screws**  
 x 4 total



**78.** Attach **Interior Door Stops** to door framing from inside of shed. Start with **Horizontal Door Stop** piece first. Use 4 - 2" screws to secure each stop. Stops should overlap door by approximately 1/2".

Parts (Steps 78)  
**Vertical Door Stops**  
 (1/2" x 2 1/2" x 72") x 2  
**Horizontal Door Stop**  
 (1/2" x 2 1/2" x 36") x 1

Hardware (Steps 78)  
**S3 - 2" Screws**  
 x 12 total



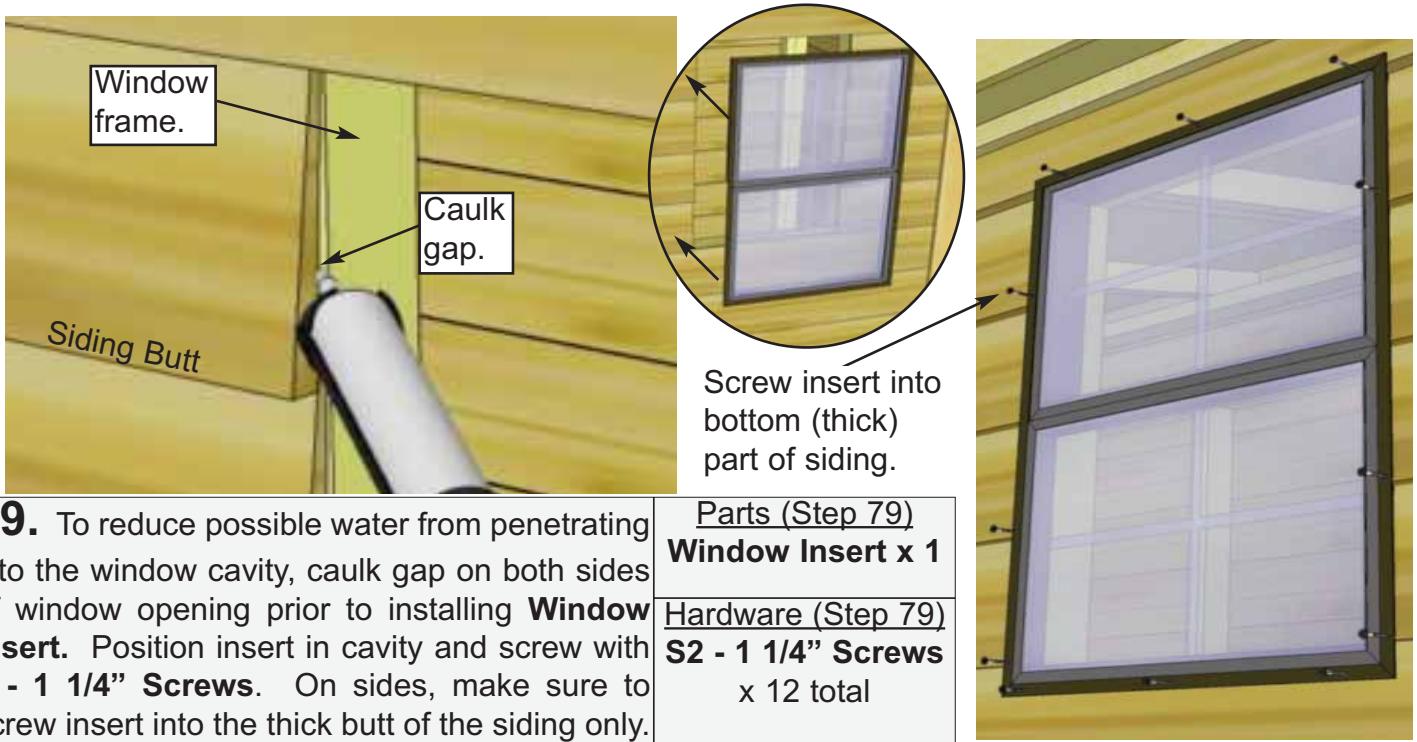

**79.** To reduce possible water from penetrating into the window cavity, caulk gap on both sides of window opening prior to installing **Window Insert**. Position insert in cavity and screw with **6 - 1 1/4" Screws**. On sides, make sure to screw insert into the thick butt of the siding only.

Parts (Step 79)  
**Window Insert x 1**

Hardware (Step 79)  
**S2 - 1 1/4" Screws**  
 x 12 total

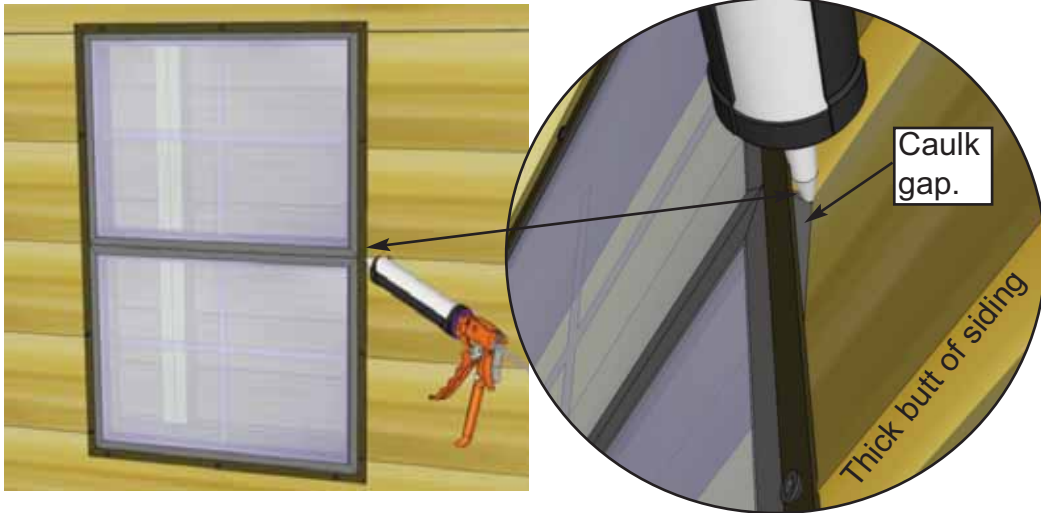

**80.** Once Insert is attached, caulk the “triangular gap” between the Insert’s outside flange and the siding. Also put a bead of caulking horizontally at top of window where the flange and siding meet. This additional caulking will also will reduce the chances of moisture entering into your shed.

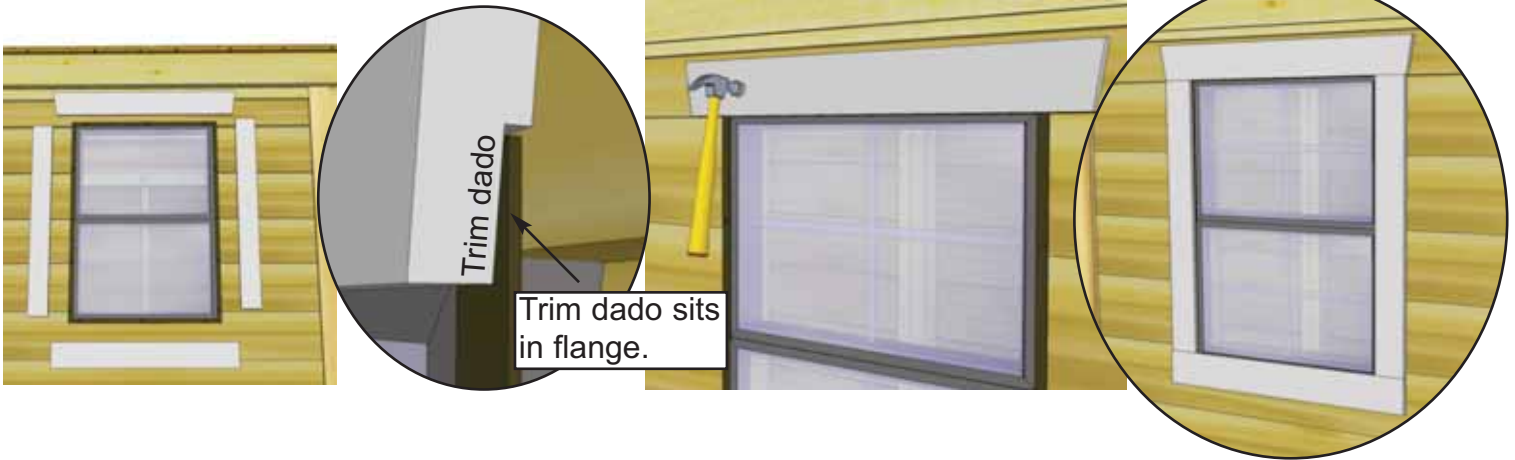

**81.** Position **Window Trim** around window doing a dry run first and attach with **4 - 1 1/2" Finishing Nails** per piece. Window trim has a small dado on reverse face. Outside flange of window will roughly sit in the dado to give a better fit.

<u>Parts (Step 81)</u> <b>Window Trim Package x 1</b> (Top - 24 1/16" Long - <i>Angle Cut Ends</i> ) x 1 (Sides & Bottom - 23" Long) x 3	<u>Hardware (Steps 81)</u> <b>N1 - 1 1/2" Finishing Nails</b> x 16 total
---	--

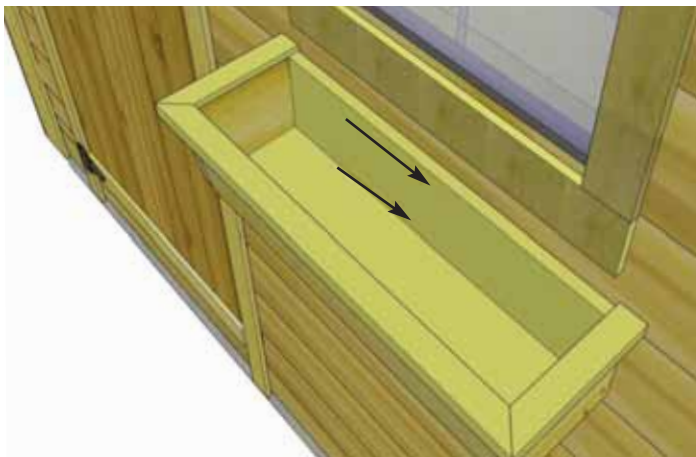

**82.** Assemble **Flower Box** with included assembly instructions on Page 39. Position completed **Flower Box** below bottom of window trim and secure with **2 - 2" Screws**. Screw from inside of box into the center Window Wall Stud. Attach second screw 2" underneath first screw, into the wall stud.

<u>Parts (Steps 82)</u> <b>Flower Box Kit x 1</b>
<u>Hardware (Steps 82)</u> <b>S3 - 2" Screws</b> x 2 total



# Outdoor Living Today Flower Box Assembly Instructions

## Parts Lists:

<b>A - Base, Rear &amp; Front Box Frames</b>	<b>(3pcs)</b>	3/4" x 5 1/2" x 23"
<b>B - End Cap Frames</b>	<b>(2pcs)</b>	3/4" x 5 1/2" x 7" / 8"
<b>C - Front Trim</b>	<b>(1 pc)</b>	3/4" x 1 1/2" x 26"
<b>D - Side Trims</b>	<b>(2 pc)</b>	3/4" x 1 1/2" x 8 3/4"
<b>E - Brackets</b>	<b>(2 pc)</b>	1 1/2" x 5 1/2" x 5 1/2"
<b>F - 1 1/4" Screws</b>		
<b>G - 1 1/4" Nails</b>		

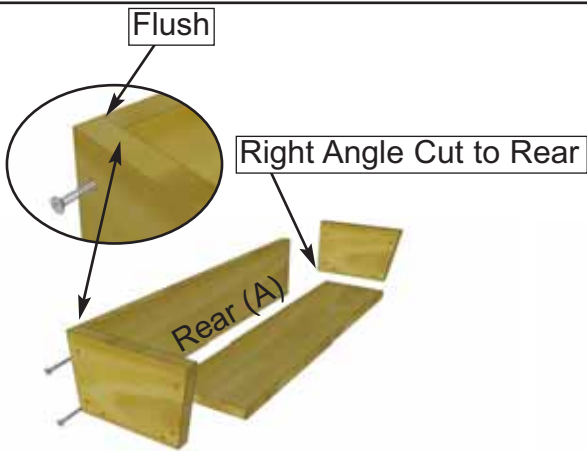
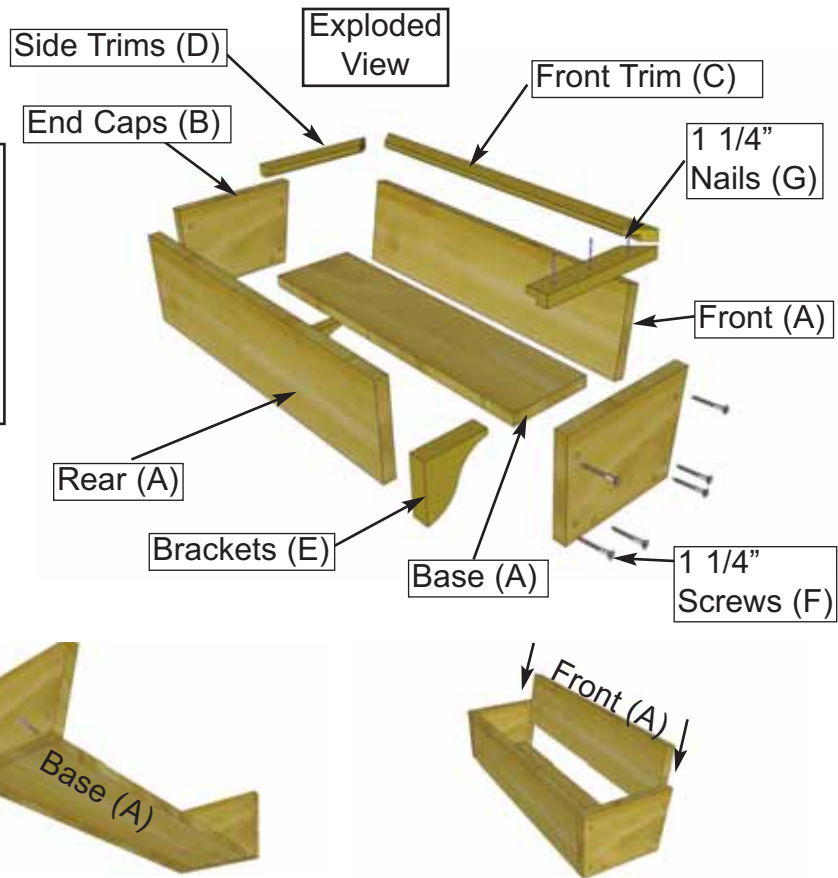

**1.** On a table position Rear Box and End Cap Frames together so flush at top. Fasten together with 2 - 1 1/4" screws. Place Base Frame tight against Rear and End Cap and flush at bottom. Secure with 2 - 1 1/4" screws. Complete attachment of remaining End Cap Frame. Slide Front Frame between End Caps.

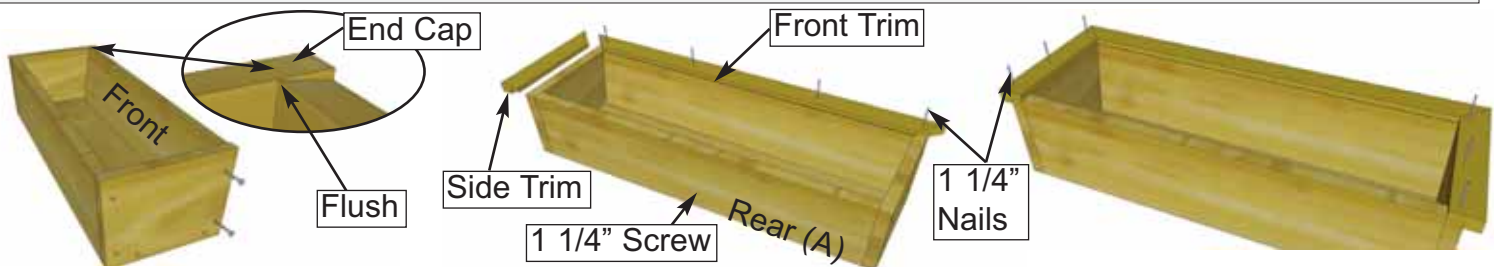

**2.** Position Front Frame Piece flush with End Cap. Attach both ends with 2 - 1 1/4" screws. Pilot hole Rear Box Frame near bottom center and secure to Base edge with 1 - 1 1/4" screw. Evenly position Front Trim (mitre cut on end and dado cut on inside bottom) tight against front frame and nail down with 4 - 1 1/4" nails. Position Side Trims as per Front and secure with 3 - 1 1/4" nails per side.

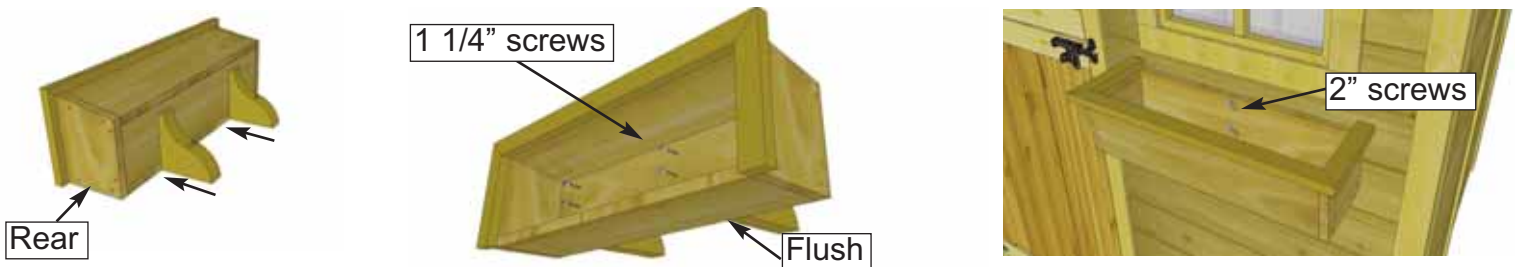

**3.** On a flat surface, flip Flower Box on it's rear face. Evenly space Brackets and secure through Base Frame and into the Brackets with 2 - 1 1/4" screws per Bracket. Position completed Flower Box beneath window trim and screw from inside of box into the center wall stud with 2 - 2" screws. (2" screws supplied with Base Kit.)



## Congratulations on building your 8x8 Gardener's Shed!

**Note:** Our Sheds are shipped as unfinished products. If exposed to the elements, the western red cedar lumber will weather to a silvery-gray color. If you prefer to keep the cedar lumber looking closer to the original color, we suggest that you treat the wood with a good oil base wood stain. You may also wish to paint your new shed rather than stain it. In both cases we recommend that you consult with a paint and stain dealer in your area for their recommendations.



We hope your experience assembling your 8x8 Gardener's Shed has been both positive and rewarding.

We value your feedback and would like to hear back from you on how well we are doing in the following areas:

1. Customer Service
2. On Time Shipping
3. Motor Freight Delivery
4. Quality of Materials
5. Assembly Manual
6. Overall Satisfaction.

Please call, write or email us at:

Outdoor Living Today

Canadian Address  
9393 287th Street  
Maple Ridge, British Columbia  
Canada V2W 1L1

United States Address  
P.O. Box 96  
Sumas, Washington  
USA 98295



The materials contained in this Assembly Manual may be downloaded or copied provided that ALL copies retain the copyright and any other proprietary notices contained on the materials. No material may be modified, edited or taken out of context such that its use creates a false or misleading statement or impression as to the positions, statements or actions.